

CLIMO PERFECT 3000 TYPELISTE

JANUAR 2024

**danish
healthcare
design**





Målskitse
 Maßzeichnung
 Dimensional drawing

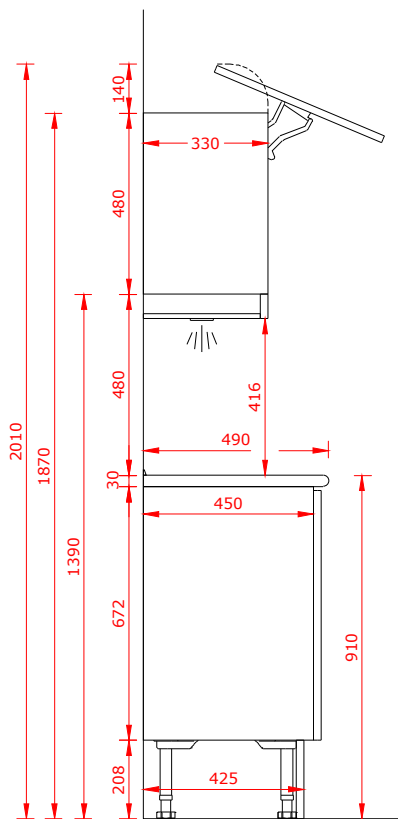

Perfect 3000 - Standard

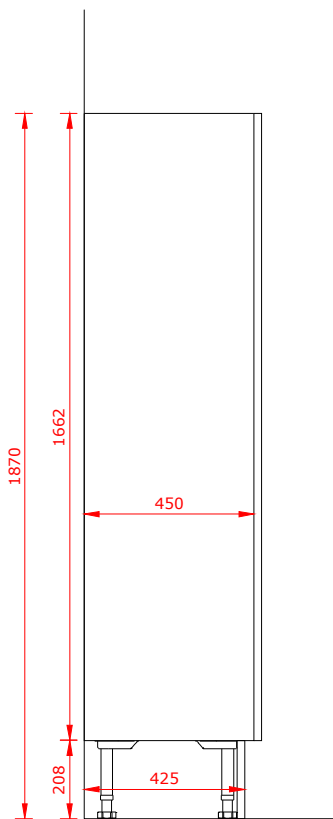

Perfect 3000 - Kompakt

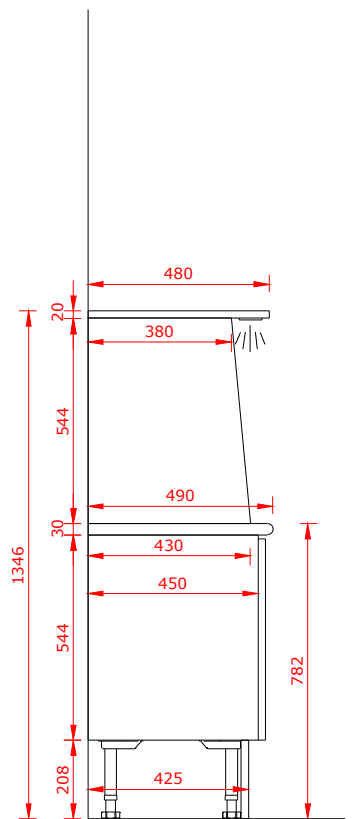

Klinikinventar

Praxismöbel

Cabinetry

Varenr. Warenr. Article nr.	Beskrivelse / Beschreibung / Description	Mål i cm Mass Measure
-----------------------------------	--	-----------------------------

Underskabe 67,2

Unterschränke 67,2

Floor cabinets 67,2

S3001

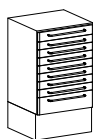

Skuffeskab, 8 skuffer 6 cm, 1 skuffe 12 cm.

Schubladenschrank, 8 Schubladen 6 cm und 1 Schublade 12 cm

Cabinet with drawers, 8 drawers 6 cm, 1 drawer 12 cm.

H 67,2

B 50

D/T 47

S3002

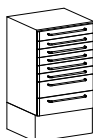

Skuffeskab, 6 skuffer 6 cm, 2 skuffer 12 cm.

Schubladenschrank, 6 Schubladen 6 cm und 2 Schubladen 12 cm.

Cabinet with drawers, 6 drawers 6 cm, 2 drawers 12 cm.

H 67,2

B 50

D/T 47

S3003



Skuffeskab, 4 skuffer 6 cm, 3 skuffer 12 cm.

Schubladenschrank, 4 Schubladen 6 cm und 3 Schubladen 12 cm.

Cabinet with drawers, 4 drawers 6 cm, 3 drawers 12 cm.

H 67,2

B 50

D/T 47

S3004



Skuffeskab, 4 skuffer 6 cm, 1 skuffe 12 cm, 1 skuffe 24 cm.

Schubladenschrank, 4 Schubladen 6 cm, 1 Schublade 12 cm und 1 Schublade 24 cm.

Cabinet with drawers, 4 drawers 6 cm, 1 drawer 12 cm, 1 drawer 24 cm.

H 67,2

B 50

D/T 47

S3005



Skuffeskab, 3 skuffer 12 cm, 1 skuffe 24 cm.

Schubladenschrank, 3 Schubladen 12 cm und 1 Schublade 24 cm.

Cabinet with drawers, 3 drawers 12 cm, 1 drawer 24 cm.

H 67,2

B 50

D/T 47

S3006



Skuffeskab, 5 skuffer 12 cm.

Schubladenschrank, 5 Schubladen 12 cm.

Cabinet with drawers, 5 drawers 12 cm.

H 67,2

B 50

D/T 47

S3007



Skuffeskab, 2 skuffer 6 cm, 4 skuffer 12 cm.

Schubladenschrank, 2 Schubladen 6 cm und 4 Schubladen 12 cm.

Cabinet with drawers, 2 drawers 6 cm, 4 drawers 12 cm.

H 67,2

B 50

D/T 47

S3008



Skuffeskab, 2 skuffer 6 cm, 2 skuffer 12 cm, 1 skuffe 24 cm.





Schubladenschrank, 2 Schubladen 6 cm, 2 Schubladen 12 cm und 1 Schublade 24 cm.

Cabinet with drawers, 2 drawers 6 cm, 2 drawers 12 cm, 1 drawer 24 cm.

H 67,2

B 50



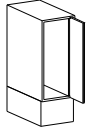
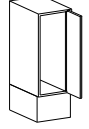

D/T 47

Varenr. Warennr. Article nr.	Beskrivelse / Beschreibung / Description	Mål i cm Mass Measure
S3010	 <p>Kombinationsskab, 2 skuffer 12 cm, 1 hylde, 1 dør højre- eller venstrehængt. Kombinierter Schrank, 2 Schubladen 12 cm, 1 Einlegeboden, 1 Tür rechts oder links angeschlagen. Combination cabinet, 2 drawers 12 cm, 1 shelf, 1 door right or left.</p>	<p>H 67,2 B 50 D/T 47</p>
S3011	 <p>Kombinationsskab, 4 skuffer 6 cm, 1 hylde, 1 dør højre- eller venstrehængt. Kombinierter Schrank, 4 Schubladen 6 cm, 1 Einlegeboden, 1 Tür rechts oder links angeschlagen. Combination cabinet, 4 drawers 6 cm, 1 shelf, 1 door right or left.</p>	<p>H 67,2 B 50 D/T 47</p>
S3012	 <p>Opbevaringsskab, 1 hylde, 1 dør højre- eller venstrehængt. Aufbewahrungs-Schrank, 1 Einlegeboden, 1 Tür rechts oder links angeschlagen, Storage cabinet, 1 shelf, 1 door right or left.</p>	<p>H 67,2 B 50 D/T 47</p>
S3013	 <p>Opbevaringsskab, 1 hylde 1 dør højre- eller venstrehængt. Aufbewahrungs-Schrank, 1 Einlegeboden, 1 Tür rechts oder links angeschlagen. Storage cabinet, 1 shelf, 1 door right or left.</p>	<p>H 67,2 B 60 D/T 47</p>
S3013-1	 <p>Kombinationsskab, 1 skuffe 6 cm, åbent rum, 1 skuffe 6 cm for tastatur, 1 hylde, 1 dør højre- eller venstrehængt. Kombinierter Schrank, 1 Schublade 6 cm, 1 offener Raum, 1 Schublade 6 cm für Tastatur, 1 Einlegeboden, 1 Tür rechts oder links angeschlagen. Combination cabinet, 1 drawer 6 cm, open space, 1 drawer 6 cm for keyboard, 1 shelf, 1 door right or left.</p>	<p>H 67,2 B 50 D/T 47</p>
S3013-2	 <p>Kombinationsskab, 1 skuffe 6 cm, åbent rum, 1 skuffe 6 cm for tastatur, 1 hylde, 1 dør højre- eller venstrehængt. Kombinierter Schrank, 1 Schublade 6 cm, 1 offener Raum, 1 Schublade 6 cm für Tastatur, 1 Einlegeboden, 1 Tür rechts oder links angeschlagen. Combination cabinet, 1 drawer 6 cm, open space, 1 drawer 6 cm for keyboard, 1 shelf, 1 door right or left.</p>	<p>H 67,2 B 60 D/T 47</p>
S3014	 <p>Skab for PC, 1 indskydelig dør. Schrank für PC, 1 Einschiebbare Tür. Cabinet for PC, 1 Push-in door.</p>	<p>H 67,2 B 30 D/T 58</p>
S3014-1	 <p>Skab for PC, 1 indskydelig dør. Schrank für PC , 1 Einschiebbare Tür. Cabinet for PC, 1 Push-in door.</p>	<p>H 67,2 B 30 D/T 47</p>
S3014-2	 <p>Skab for PC, 1 jalousilåge. Schrank für PC, 1 Rolladentür. Cabinet for PC, 1 roll front.</p>	<p>H 67,2 B 30 D/T 47</p>
S3014-3	 <p>Skab for PC, 1 jalousilåge. Schrank für PC, 1 Rolladentür. Cabinet for PC, roll front.</p>	<p>H 67,2 B 30 D/T 58</p>

Varenr. Warennr. Article nr.	Beskrivelse / Beschreibung / Description	Mål i cm Mass Measure
S3015	 <p>Udrøringssskab, specialudtræk med udrøringsplade og plads for mix-udstyr, incl. indsats T3065 m. stikdåse, 1 skuffe 12 cm, 1 skuffe 24 cm.</p> <p>Anmisch-Schrank, 1 ausziehbare Klappe für Zusatzgeräte in rostfreiem Stahl und 1 Einsatz das Mischgerät, 1 Steckdose. 1 Schublade 12 cm, 1 Schublade 24 cm.</p> <p>Amalgamator cabinet, Topdrawer with pull-out and drop-down front for mixing, incl. T3065 insert incl. socket, 1 drawer 12 cm, 1 drawer 24 cm.</p>	<p>H 67,2</p> <p>B 50</p> <p>D/T 47</p>
S3015-1	 <p>Udrøringssskab, udtræk med stikdåse og udrøringsplade i laminat for mix-udstyr, 1 skuffe 12 cm, 1 skuffe 24 cm.</p> <p>Anmisch-Schrank, 1 ausziehbare Klappe für Zusatzgeräte in Laminat und 1 Einsatz das Mischgerät, 1 Steckdose. 1 Schublade 12 cm, 1 Schublade 24 cm.</p> <p>Amalgamator cabinet incl. socket, with pull-out and drop-down front in laminate for mixing, 1 drawer 12 cm, 1 drawer 24 cm.</p>	<p>H 67,2</p> <p>B 50</p> <p>D/T 47</p>
S3016	 <p>Universalskab, udtræksplade til ekstra udstyr, kan også suppleres med indsatserne T3067 og T3069, 2 skuffer 12 cm.</p> <p>Universal-Schrank, 1 Auszug für Zusatzgeräte, kan auch kombiniert werden mit T3067 und T3069, 2 Schubladen 12 cm.</p> <p>Universal cabinet. Push-in flap for equipment, can also be supplied with the inserts T3067 and T3069, 2 drawers 12 cm.</p>	<p>H 67,2</p> <p>B 50</p> <p>D/T 47</p>
S3016-1	 <p>Universalskab, indskydelig låge med fast afrundet kant på korpus, udtræksplade til ekstra udstyr, kan også suppleres med indsatserne T3067 og T3069, 2 skuffer 12 cm.</p> <p>Universal-Schrank, 1 einschiebbare Tür und fest abgerundeter Kante am Korpus, 1 Auszug für Zusatzgeräte, kan auch kombiniert werden mit T3067 und T3069, 2 Schubladen 12 cm.</p> <p>Universal cabinet, push-in door with a firmly edge at the cabinet body, push-in flap for equipment, can also be supplied with the inserts T3067 and T3069, 2 drawers 12 cm.</p>	<p>H 67,2</p> <p>B 50</p> <p>D/T 47</p>
S3017	 <p>Udrøringssskab, indskydelig låge, udrøringsplade med opalglas, derunder specialudtræk for mix-udstyr, m/stikdåse, 2 skuffer 12 cm.</p> <p>Anmisch-Schrank, 1 einschiebbare Tür. Auszug mit Opalglasplatte, Einsatz für Zusatzgeräte, mit Steckdose, 2 Schubladen 12 cm.</p> <p>Amalgamator cabinet, push-in door, and pull-out opaque glassboard for mixing, 1 universal drawer for equipment, incl. socket, 2 drawers 12 cm.</p>	<p>H 67,2</p> <p>B 50</p> <p>D/T 47</p>
S3017-1	 <p>Udrøringssskab. Indskydelig låge med fast afrundet kant på korpus, udrøringsplade med opalglas, derunder specialudtræk for mix-udstyr, m. stikdåse, 2 skuffer 12 cm.</p> <p>Anmisch-Schrank. 1 einschiebbare Tür, mit fester abgerundeter Kante am Korpus, Auszug mit Opalglasplatte, Einsatz für Zusatzgeräte, 1 Steckdose, 2 Schubladen 12 cm.</p> <p>Amalgamator cabinet, push-in door with a firmly edge at the cabinet body, pull-out opaque glassboard for mixing, 1 universal drawer for equipment, incl. socket, 2 drawers 12 cm.</p>	<p>H 67,2</p> <p>B 50</p> <p>D/T 47</p>
S3019	 <p>Apparaturskab. Indskydelig låge, 1 universaludtræk for elektroniske apparater, m. stikdåse, 2 skuffer 12 cm.</p> <p>Geräte-Schrank, 1 einschiebbare Tür, 1 Auszug mit Einsatz für Zusatzgeräte, 1 Steckdose, 2 Schubladen 12 cm.</p> <p>Cabinet for electro surgery. Push-in door, 1 push-in flap, incl. socket, 2 drawers 12 cm.</p>	<p>H 67,2</p> <p>B 50</p> <p>D/T 47</p>
S3019-1	 <p>Apparaturskab. Indskydelig låge med fast afrundet kant på korpus, 1 universaludtræk for elektroniske apparater, m. stikdåse, 2 skuffer 12 cm.</p> <p>Geräte-Schrank. 1 einschiebbare Tür, mit fester abgerundeter Kante am Korpus, 1 Auszug mit Einsatz für Geräte, 1 Steckdose, 2 Schubladen 12 cm.</p> <p>Cabinet for electro surgery. Push-in door with a firmly edge at the cabinet body, with push-in flap incl. socket, 2 drawers 12 cm.</p>	<p>H 67,2</p> <p>B 50</p> <p>D/T 47</p>

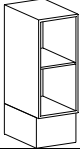
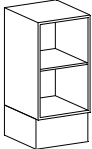
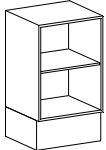
Varenr. Warennr. Article nr.	Beskrivelse / Beschreibung / Description	Mål i cm Mass Measure
S3021	 <p>Lattergasskab. Udtræk for lattergas, indskydelig dør. Lachgas-Schrank. 1 einschiebbare Tür, 1 Auszug für Lachgas Cabinet for laughing gas. Extension plate for laughing gas, push-in door.</p>	<p>H 67,2 B 40 D/T 47</p>
S3021-1	 <p>Lattergasskab. Uden udtræk, indskydelig dør. Lachgas-Schrank. 1 einschiebbare Tür, ohne Auszug für Lachgas. Cabinet for laughing gas. Without extension plate, push-in door.</p>	<p>H 67,2 B 40 D/T 47</p>
S3022	 <p>Skab for sug. 1 udtræksplade 12 cm med front for montering af sugespidsler. Absaug-Schrank.mit ausziehbarer Platte zum Einbau einer Schlauchanlage Cabinet for suction. 12 cm extension front for mounting of suction.</p>	<p>H 67,2 B 30 D/T 47</p>
S3023	 <p>Skab for sug. 1 udtræksplade 12 cm med front for montering af sugespidsler. Absaug-Schrank. mit ausziehbarer Platte zum Einbau einer Schlauchanlage Cabinet for suction. 12 cm extension front for mounting of suction.</p>	<p>H 67,2 B 50 D/T 47</p>
S3024	 <p>Kassetteskab for 10 bakker m/låg, indskydelig dør. Tray-Schrank für 10 Normtrays mit Deckel, 1 einschiebbare Tür. Instrument tray cabinet for 10 trays with cover, push-in door.</p>	<p>H 67,2 B 30 D/T 47</p>
S3024-1	 <p>Kassetteskab for 20 bakker uden låg, indskydelig dør. Tray-Schrank für 20 Normtrays ohne Deckel, 1 einschiebbare Tür. Instrument tray cabinet for 20 trays with out cover, push-in door.</p>	<p>H 67,2 B 30 D/T 47</p>
S3025	 <p>Opbevaringsskab. Indskydelig dør, 1 hylde. Aufbewahrungs-Schrank mit 1 Einlegeboden, 1 einschiebbare Tür Storage cabinet. Push-in door, 1 shelf.</p>	<p>H 67,2 B 30 D/T 47</p>
S3026	 <p>Hjørneskab. 83x83 cm, 1 dør højre- eller venstrehængt, 1 hylde. Eckschrank. 83x83 cm, 1 Einlegeboden, 1 Tür rechts oder links angeschlagen, Corner cabinet. 83x83 cm, 1 door right or left, 1 shelf.</p>	<p>H 67,2 B D/T</p>
S3027	 <p>Vaskeskab, 1 affaldsklap, 1 dør højre- eller venstrehængt. Waschbeckenschrank, 1 Abfallklappe, 1 Tür rechts oder links angeschlagen. Cabinet for sink, 1 waste compartment, 1 door right or left.</p>	<p>H 67,2 B 50 D/T 47</p>
S3027-1	 <p>Vaskeskab m/fodbetjent affaldsklap, 1 dør højre- eller venstrehængt. Waschbeckenschrank, 1 fussbediente Abfallklappe, 1 Tür rechts oder links angeschlagen. Cabinet for sink, 1 foot operated flap for waste, 1 door right or left.</p>	<p>H 67,2 B 50 D/T 47</p>

Varenr. Warennr. Article nr.	Beskrivelse / Beschreibung / Description	Mål i cm Mass Measure
S3027-2	 <p>Vaskeskab m/knæbetjent affaldsklap. Waschbeckenschrank, 1 kniebediente Abfallklappe. Cabinet for sink, knee operated flap for waste.</p>	<p>H 67,2 B 50 D/T 47</p>
S3027-3	 <p>Vaskeskab m/selvåbnende udtræk. Waschbeckenschrank, selbstöffnender Auszug. Cabinet for sink, 1 automatic extension for waste.</p>	<p>H 67,2 B 50 D/T 47</p>
S3027-4	 <p>Vaskeskab m/elektronisk selvåbnende udtræk. Waschbeckenschrank, elektronische selbstöffnender Auszug. Cabinet for sink, 1 electronic controlled extension for waste.</p>	<p>H 67,2 B 50 D/T 47</p>
S3028	 <p>Vaskeskab med 12 cm blænde for oven, 1 dør højre- eller venstrehængt. Waschbeckenschrank mit 12 cm Blende oben, 1 Tür rechts oder links angeschlagen. Cabinet for sink with 12 cm adjusting panel above, 1 door right or left.</p>	<p>H 67,2 B 50 D/T 47</p>
S3029	 <p>Vaske/hjørneskab. 83x83 cm, 1 affaldsklap, 1 dør højre- eller venstrehængt. Eckschrank mit Waschbecken 83x83 cm, 1 Abfallklappe, 1 Tür rechts oder links angeschlagen. Cabinet for sink/Corner cabinet. 83x83 cm, 1 waste compartment, 1 door right or left.</p>	<p>H 67,2 B 50 D/T</p>
S3033	 <p>Ombygningssæt til S3027 vaskeskab med affaldsklap. Incl. hængsler og greb. Umbauset für S3027 Waschbeckenschrank mit Ablaufklappe. Inkl. Scharniere und Griff. Conversion set for S3027 cabinet for sink. Incl. hinges and handle.</p>	<p>H 67,2 B 50 D/T</p>
S3033-1	 <p>Ombygningssæt til S3027-3 vaskeskab med selvåbnende affaldsudtræk. Umbauset für S3027-3 Waschbeckenschrank mit selbstöffnender Auszug. Conversion set for S3027-3 cabinet for sink, 1 automatic extension for waste.</p>	<p>H 67,2 B 50 D/T 47</p>
S3030-1	 <p>Affaldsskab. 1 dør højre- eller venstrehængt, 1 hylde. Abfallschrank. 1 Einlegeboden, 1 Tür rechts oder links angeschlagen, Cabinet for waste. 1 door right or left, 1 shelf.</p>	<p>H 67,2 B 30 D/T 47</p>
S3031	 <p>Opbevaringsskab. 1 dør højre- eller venstrehængt, 1 hylde Aufbewahrungs-Schrank 1 Einlegeboden, 1 Tür rechts oder links Storage cabinet. 1 door right or left, 1 shelf.</p>	<p>H 67,2 B 30 D/T 47</p>
S3032	 <p>Opbevaringsskab. 1 dør højre- eller venstrehængt, 1 hylde. Aufbewahrungs-Schrank, 1 Einlegeboden, 1 Tür rechts oder links angeschlagen, Storage cabinet. 1 door right or left, 1 shelf.</p>	<p>H 67,2 B 40 D/T 47</p>

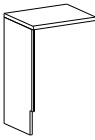
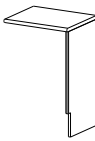
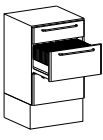
Varenr. Warennr. Article nr.	Beskrivelse / Beschreibung / Description	Mål i cm Mass Measure
S3130	 <p>Reol, 1 stilbar hylde. Regal Element, 1 verstellbare Einlegeboden. Bookcase, 1 adjustable shelf.</p>	<p>H 67,2 B 30 D/T 45</p>
S3140	 <p>Reol, 1 stilbar hylde. Regal Element, 1 verstellbare Einlegeboden. Bookcase, 1 adjustable shelf.</p>	<p>H 67,2 B 40 D/T 45</p>
S3150	 <p>Reol, 1 stilbar hylde. Regal Element, 1 verstellbare Einlegeboden. Bookcase, 1 adjustable shelf.</p>	<p>H 67,2 B 50 D/T 45</p>
S3041	 <p>Venstre tilpasningsstykke, incl. frontbeklædning 10 cm bredt. Linke Blende/Passtück mit Frontverkleidung 10 cm breit. Left front adjusting panel incl. frontcovering, 10 cm width.</p>	<p>H 67,2 B D/T</p>
S3041-1	 <p>Venstre tilpasningsstykke, excl. frontbeklædning, 10 cm bredt. Blende / Passtück R/L ohne Frontverkleidung, 10 cm breit. Left front adjusting panel without frontcovering, 10 cm width.</p>	<p>H 67,2 B D/T</p>
S3042	 <p>Højre tilpasningsstykke, incl. frontbeklædning 10 cm bredt. Rechte Blende/Passtück mit Frontverkleidung 10 cm breit. Right front adjusting panel incl. frontcovering, 10 cm width.</p>	<p>H 67,2 B D/T</p>
S3042-1	 <p>Højre tilpasningsstykke, excl. frontbeklædning, 10 cm bredt. Rechte Blende/Passtück ohne Frontverkleidung, 10 cm breit. Right front adjusting panel without frontcovering, 10 cm width.</p>	<p>H 67,2 B D/T</p>
S3043	 <p>Venstre støttegavl. Stützwange links Left Support end.</p>	<p>H 88 B 2 D/T 47</p>
S3044	 <p>Højre støttegavl. Stützwange rechts. Right Support end.</p>	<p>H 88 B 2 D/T 47</p>
S3055	 <p>Kartoteksskab. 1 skuffe 12 cm, 2 skuffer 24 cm for A5 kort. Karteischränk. 1 Schublade 12 cm, 2 Schubladen 24 cm mit Einsatz für DIN A5 Karten. Filing cabinet. 1 drawer 12 cm, 2 drawers 24 cm for A5 cards.</p>	<p>H 67,2 B 50 D/T 47</p>

Varenr. Warennr. Article nr.	Beskrivelse / Beschreibung / Description	Mål i cm Mass Measure
------------------------------------	--	-----------------------------

Højskabe klinik	Hochschränke Behandlung	High cabinets Clinic
-----------------	-------------------------	----------------------

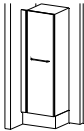
S3071	 <p>Venstre tilpasningsstykke, incl. frontbeklædning 10 cm bredt. Linke Passtück mit Frontverkleidung 10 cm breit. Left front adjusting panel incl. frontcovering, 10 cm width.</p>	<p>H 166,4 B D/T</p>
-------	--	---

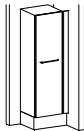
S3072	 <p>Højre tilpasningsstykke, incl. frontbeklædning 10 cm bredt. Rechte Passtück mit Frontverkleidung 10 cm breit. Right front adjusting panel incl. frontcovering, 10 cm width.</p>	<p>H 166,4 B D/T</p>
-------	--	---

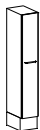
S3530	 <p>Højt skab, 1 dør højre- eller venstrehængt, 4 hylder. Hochschrank, 1 Tür rechts oder links angeschlagen, 4 Einlegeböden. High storage cabinet, 1 door right or left, 4 shelves.</p>	<p>H 166,4 B 30 D/T 47</p>
-------	--	---

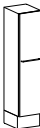
S3540	 <p>Højt skab, 1 dør højre- eller venstrehængt, 4 hylder. Hochschrank, 1 Tür rechts oder links angeschlagen, 4 Einlegeböden. High storage cabinet, 1 door right or left, 4 shelves.</p>	<p>H 166,4 B 40 D/T 47</p>
-------	---	---

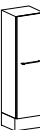
S3550	 <p>Højt skab, 1 dør højre- eller venstrehængt, 4 hylder. Hochschrank, 1 Tür rechts oder links angeschlagen, 4 Einlegeböden. High storage cabinet, 1 door right or left, 4 shelves.</p>	<p>H 166,4 B 50 D/T 47</p>
-------	--	---

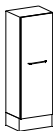
S3560	 <p>Højt skab, 1 dør højre- eller venstrehængt, 4 hylder. Hochschrank, 1 Tür rechts oder links angeschlagen, 4 Einlegeböden. High storage cabinet, 1 door right or left, 4 shelves.</p>	<p>H 166,4 B 60 D/T 47</p>
-------	--	---

Varenr. Warennr. Article nr.	Beskrivelse / Beschreibung / Description	Mål i cm Mass Measure
------------------------------------	--	-----------------------------

Underskabe 54,4

Unterschränke 54,4

Floor cabinets 54,4

S3401



Skuffeskab. Åbent rum, 1 udtræksplade, 4 skuffer 6 cm, 1 skuffe 12 cm.

Schubladenschrank. 1 offener Raum, 1 Schreibplatte, 4 Schubladen 6 cm, 1 Schublade 12 cm.

Cabinet with drawers. Open space, 1 pull out desk, 4 drawers 6 cm, 1 drawer 12 cm.

H 54,4

B 50

D/T 47

S3402



Skuffeskab. Åbent rum, 1 udtræksplade, 2 skuffer 6 cm, 2 skuffer 12 cm.

Schubladenschrank. 1 offener Raum, 1 Schreibplatte, 2 Schubladen 6 cm, 2 Schubladen 12 cm.

Cabinet with drawers. Open space, 1 pull out desk, 2 drawers 6 cm, 2 drawers 12 cm.

H 54,4

B 50

D/T 47

S3403



Skuffeskab. Åbent rum, 1 udtræksplade, 3 skuffer 12 cm.

Schubladenschrank. 1 offener Raum, 1 Schreibplatte, 3 Schubladen 12 cm.

Cabinet with drawers. Open space, 1 pull out desk, 1 drawer 12 cm, 1 drawer 24 cm.

H 54,4

B 50

D/T 47

S3404



Skuffeskab. Åbent rum, 1 udtræksplade, 1 skuffe 12 cm, 1 skuffe 24 cm.

Schubladenschrank. 1 offener Raum, 1 Schreibplatte, 1 Schublade 12 cm, 1 Schublade 24 cm.

Cabinet with drawers. Open space, 1 pull out desk, 1 drawer 12 cm, 1 drawer 24 cm.

H 54,4

B 50

D/T 47

S3405

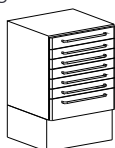

Skuffeskab. 6 skuffer 6 cm, 1 skuffe 12 cm.

Schubladenschrank. 6 Schubladen 6 cm, 1 Schublade 12 cm.

Cabinet with drawers. 6 drawer 6 cm, 1 drawer 12 cm.

H 54,4

B 50

D/T 47

S3406



Skuffeskab. 4 skuffer 6 cm, 2 skuffer 12 cm.

Schubladenschrank. 4 Schubladen 6 cm, 2 Schubladen 12 cm.

Cabinet with drawers. 4 drawers 6 cm, 2 drawers 12 cm.

H 54,4

B 50

D/T 47

S3407



Skuffeskab. 2 skuffer 6 cm, 3 skuffer 12 cm.

Schubladenschrank. 2 Schubladen 6 cm, 3 Schubladen 12 cm.

Cabinet with drawers. 2 drawers 6 cm, 3 drawers 12 cm.

H 54,4

B 50

D/T 47

S3408

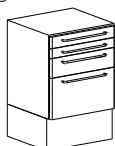

Skuffeskab. 2 skuffer 6 cm, 1 skuffe 12 cm, 1 skuffe 24 cm.

Schubladenschrank. 2 Schubladen 6 cm, 1 Schublade 12 cm, 1 Schublade 24 cm.

Cabinet with drawers. 2 drawers 6 cm, 1 drawer 12 cm, 1 drawer 24 cm.

H 54,4

B 50

D/T 47

S3412

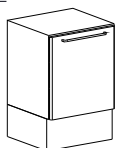

Opbevaringsskab, 1 dør højre- eller venstrehængt, 1 hylde.







Aufbewahrungs-Schrank, 1 Einlegeboden, 1 Tür rechts oder links angeschlagen,

Storage cabinet, 1 door right or left, 1 shelf.

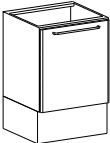
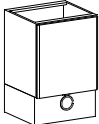
H 54,4

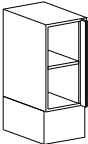
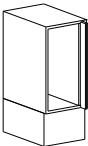
B 50

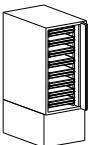
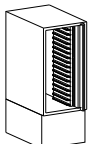
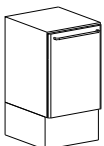
D/T 47

Varenr. Warennr. Article nr.	Beskrivelse / Beschreibung / Description	Mål i cm Mass Measure
S3427	 <p>Vaskeskab, 1 dør højre- eller venstrehængt. Waschbeckenschrank. 1 Tür rechts oder links angeschlagen. Cabinet for sink, 1 door right or left.</p>	<p>H 54,4 B 50 D/T 47</p>
S3427-2	 <p>Vaskeskab m/selvåbnende udtræk. Waschbeckenschrank, Selbstöffnender Auszug. Cabinet for sink, 1 automatic extension for waste.</p>	<p>H 54,4 B 50 D/T 47</p>
S3430	 <p>Opbevaringsskab, 1 dør højre- eller venstrehængt, 1 hylde. Aufbewahrungs-Schrank, 1 Einlegeboden., 1 Tür rechts oder links angeschlagen, Storage cabinet, 1 door right or left, 1 shelf.</p>	<p>H 54,4 B 30 D/T 47</p>
S3431	 <p>Opbevaringsskab. Indskydelig dør, 1 hylde. Aufbewahrungs-Schrank, 1 Einlegeboden, 1 einschiebbare Tür Storage cabinet. Push-in door, 1 shelf.</p>	<p>H 54,4 B 30 D/T 47</p>
S3432	 <p>Skab for PC. Indskydelig dør, PC max mål H=49,0 B=19,5 cm. Schrank für PC. einschiebbare Tür , PC max mass H=49,0 B=19,5 cm. Cabinet for PC. Push-in door, PC max measure H=49,0 B=19,5 cm.</p>	<p>H 54,4 B 30 D/T 47</p>
S3433	 <p>Jalousiskab for PC. PC max mål H=39,0 B=26,0 cm. Schrank für PC mit Rolladentür, PC max mass H=39,0 B=26,0 cm. Roll-front cabinet for PC. PC max measure H=39,0 W=26,0 cm.</p>	<p>H 54,4 B 30 D/T 45</p>
S3434	 <p>Kassetteskab for 8 bakker m/låg, indskydelig dør. Tray-Schrank für 8 Normtrays mit Deckel, 1 einschiebbare Tür Instrument tray cabinet for 8 Trays, push-in door.</p>	<p>H 54,4 B 30 D/T 47</p>
S3435	 <p>Kassetteskab for 16 bakker u/låg, indskydelig dør. Tray-Schrank für 16 Normtrays ohne Deckel, 1 einschiebbare Tür Instrument tray cabinet for 16 instrument trays without cover, push-in door.</p>	<p>H 54,4 B 30 D/T 47</p>
S3440	 <p>Opbevaringsskab, 1 dør højre- eller venstrehængt, 1 hylde. Aufbewahrungs-Schrank, 1 Einlegeboden, 1 Tür rechts oder links angeschlagen, Storage cabinet, 1 door right or left, 1 shelf.</p>	<p>H 54,4 B 40 D/T 47</p>
S3441	 <p>Venstre tilpasningsstykke, incl. frontbeklædning 10 cm bredt. Linke Blende/Passtück mit Frontverkleidung 10 cm breit. Left front adjusting panel incl. frontcovering, 10 cm width.</p>	<p>H 54,4 B D/T</p>

Varenr. Warennr. Article nr.	Beskrivelse / Beschreibung / Description	Mål i cm Mass Measure
------------------------------------	--	-----------------------------

S3442



Højre tilpasningsstykke, incl. frontbeklædning 10 cm bredt.
Rechte Blende/Passtück mit Frontverkleidung 10 cm breit.
Right front adjusting panel incl. frontcovering, 10 cm width.

H 54,4
B
D/T

Top Skabe

Topp-Schränke

Top cabinets

V3430

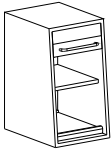

Topskab. 1 udtræksplade, 1 hylde.
Oberschrank mit Rolladentür, 1 Einlegeboden, 1 Ausziehbare Platte
Top cabinet. 1 push-in flap, 1 shelf.

H 54,4
B 30
D/T 43/38

V3440



Topskab. 1 hylde, 1 udtræksplade, incl. stikkontakt.
Oberschrank mit Rolladentür, 1 Einlegeboden, 1 ausziehbare Platte, 1 Steckdose,
Top cabinet. 1 shelf, 1 push-in flap, incl. socket.

H 54,4
B 40
D/T 43/38

V3450



Topskab. 1 hylde, 1 udtræksplade, incl. stikkontakt.
Oberschrank mit Rolladentür, 1 Einlegeboden, 1 Steckdose, 1 ausziehbare Platte
Top cabinet. 1 shelf, 1 push-in flap, incl. socket.

H 54,4
B 50
D/T 43/38

V3451

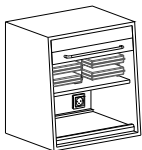

Topskab. 1 udtræksplade, indsats for 4 bakker m. låg incl. Stikkontakt.
Oberschrank mit Rolladentür, Einsatz für 4 Normtrays mit Deckel, 1 Steckdose, 1 Ausziehbare Platte
Top cabinet. 1 push-in flap, plastic liner for 4 instrument trays, incl. Socket.



H 54,4
B 50
D/T 43/38

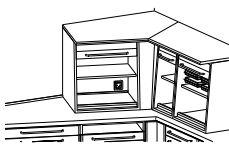

V3460



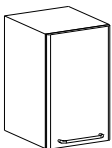
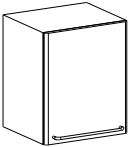
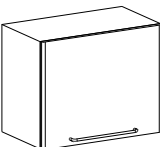
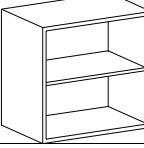

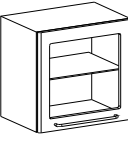

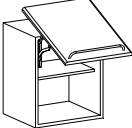
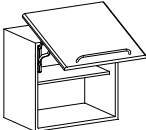
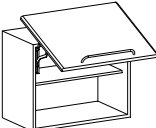
Hjørnesamling af topskabe.
Ecksammlung für Oberschränke
Corner joint, top cabinets.

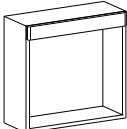
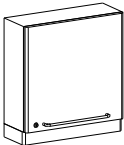
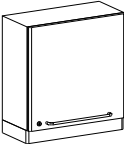
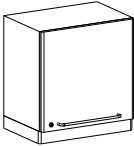
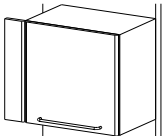



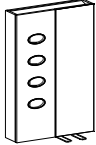

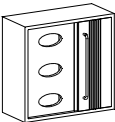
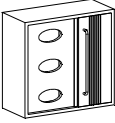
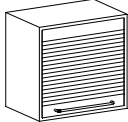
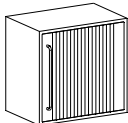
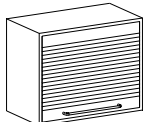
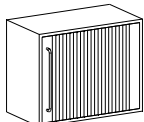

H
B
D/T







Varenr. Warennr. Article nr.	Beskrivelse / Beschreibung / Description	Mål i cm Mass Measure
Vægskabe	Wandschränke	Wall cabinets
V3030	 <p>Vægskab, 1 dør højre- eller venstrehængt, 1 hylde. Oberschrank, 1 Einlegeboden, 1 Tür rechts oder links angeschlagen, Storage cabinet, 1 door right or left, 1 shelf.</p>	<p>H 48 B 30 D/T 35</p>
V3040	 <p>Vægskab, 1 dør højre- eller venstrehængt, 1 hylde. Oberschrank, 1 Einlegeboden, 1 Tür rechts oder links angeschlagen, Storage cabinet, 1 door right or left, 1 shelf.</p>	<p>H 48 B 40 D/T 35</p>
V3050	 <p>Vægskab, 1 dør højre- eller venstrehængt, 1 hylde. Oberschrank, 1 Einlegeboden, 1 Tür rechts oder links angeschlagen. Storage cabinet, 1 door right or left, 1 shelf.</p>	<p>H 48 B 50 D/T 35</p>
V3060	 <p>Vægskab, 1 dør højre- eller venstrehængt, 1 hylde. Oberschrank, 1 Einlegeboden, 1 Tür rechts oder links angeschlagen, Storage cabinet, 1 door right or left, 1 shelf.</p>	<p>H 48 B 60 D/T 35</p>
V3130	 <p>Reol, 1 stilbar hylde. Regal Element, 1 verstellbare Einlegeboden. Bookcase, 1 adjustable shelf.</p>	<p>H 48 B 30 D/T 33</p>
V3140	 <p>Reol, 1 stilbar hylde. Regal Element, 1 verstellbare Einlegeboden. Bookcase, 1 adjustable shelf.</p>	<p>H 48 B 40 D/T 33</p>
V3150	 <p>Reol, 1 stilbar hylde. Regal Element, 1 verstellbare Einlegeboden. Bookcase, 1 adjustable shelf.</p>	<p>H 48 B 50 D/T 33</p>
V3041	 <p>Vitrineskab, 1 vitrinelåge højre- eller venstrehængt samt 1 glashylde. Oberschrank, 1 Glass-Einlegeboden, 1 Vitrinen Tür rechts oder links angeschlagen, Glass cabinet, 1 glassdoor right or left, 1 glass shelf.</p>	<p>H 48 B 40 D/T 35</p>
V3051	 <p>Vitrineskab, 1 vitrinelåge højre- eller venstrehængt samt 1 glashylde. Oberschrank, 1 Glass-Einlegeboden, 1 Vitrinen Tür rechts oder links angeschlagen, Glass cabinet, 1 glassdoor right or left, 1 glass shelf.</p>	<p>H 48 B 50 D/T 35</p>
V3061	 <p>Vitrineskab, 1 vitrinelåge højre- eller venstrehængt samt 1 glashylde. Oberschrank, 1 Glass-Einlegeboden, 1 Vitrinen Tür rechts oder links angeschlagen, Glass cabinet, 1 glassdoor right or left, 1 glass shelf.</p>	<p>H 48 B 60 D/T 35</p>





Varenr. Warennr. Article nr.	Beskrivelse / Beschreibung / Description	Mål i cm Mass Measure
V3033	 <p>Vægskab, 1 dør på hævebeslag samt 1 hylde. Oberschrank, 1 Einlegeboden, 1 Hebetür, Wall cabinet, 1 Lift-up door, 1 shelf.</p>	<p>H 48 B 30 D/T 35</p>
V3043	 <p>Vægskab, 1 dør på hævebeslag samt 1 hylde. Oberschrank, , 1 Einlegeboden, 1 Hebetür, Wall cabinet, 1 Lift-up door, 1 shelf.</p>	<p>H 48 B 40 D/T 35</p>
V3053	 <p>Vægskab, 1 dør på hævebeslag samt 1 hylde. Oberschrank, 1 Einlegeboden, 1 Hebetür, Wall cabinet, 1 Lift-up door, 1 shelf.</p>	<p>H 48 B 50 D/T 35</p>
V3063	 <p>Vægskab, 1 dør på hævebeslag samt 1 hylde. Oberschrank, 1 Einlegeboden, 1 Hebetür, Wall cabinet, 1 Lift-up door, 1 shelf.</p>	<p>H 48 B 60 D/T 35</p>
V3054-3	 <p>Dispenserskab, 1 dør højre- eller venstrehængt med spejl, 1 papirrulledispenser. Spender-Schrank, 1 Papierrollenspender, 1 Spiegel, 1 Tür rechts oder links angeschlagen Dispenser cabinet, 1 door right or left, 1 mirror, 1 dispenser for roll of paper.</p>	<p>H 48 B 50 D/T 24</p>
V3055	 <p>Spejlskab. Lysarmatur indbygget foroven. Spiegelschrank mit Beleuchtung Mirror cabinet with vanity light.</p>	<p>H 48 B 50 D/T 19</p>
V3056	 <p>Medicinskab, 1 dør højre- eller venstrehængt, 2 glashylder samt lås. Medikamentenschrank, mit 2 Glass - Einlegeböden, 1 Schloss, 1 Tür rechts oder links angeschlagen, Medicine cabinet, 1 door right or left, 2 glass shelves and 1 lock.</p>	<p>H 48 B 50 D/T 19</p>
V3056-1	 <p>Medicinskab, 1 dør højre- eller venstrehængt, 2 glashylder samt lås. Medikamentenschrank, mit 2 Glass - Einlegeböden, 1 Schloss, 1 Tür rechts oder links angeschlagen, Medicine cabinet, 1 door right or left, 2 glass shelves and 1 lock.</p>	<p>H 48 B 50 D/T 24</p>
V3056-2	 <p>Medicinskab, 1 dør højre- eller venstrehængt, 2 glashylder samt lås. Medikamentenschrank, mit 2 Glass - Einlegeböden, 1 Schloss, 1 Tür rechts oder links angeschlagen, Medicine cabinet, 1 door right or left, 2 glass shelves and 1 lock.</p>	<p>H 48 B 50 D/T 35</p>
V3057	 <p>Venstre tilpasningsstykke, incl. frontbeklædning 10 cm bredt. Linke Blende/Passtück mit Frontverkleidung 10 cm breit. Left front adjusting panel incl. frontcovering, 10 cm width.</p>	<p>H 48 B D/T</p>

Varenr. Warennr. Article nr.	Beskrivelse / Beschreibung / Description	Mål i cm Mass Measure
V3057-1	 <p>Venstre tilpasningsstykke, excl. frontbeklædning, 10 cm bredt. Linke oder Rechte Blende/Passtück ohne Frontverkleidung, 10 cm breit. Left front adjusting panel without frontcovering, 10 cm width.</p>	H 48 B D/T
V3058	 <p>Højre tilpasningsstykke, incl. frontbeklædning 10 cm bredt. Rechte Blende/Passtück mit Frontverkleidung 10 cm breit. Right front adjusting panel incl. frontcovering, 10 cm width.</p>	H 48 B D/T
V3058-1	 <p>Højre tilpasningsstykke, excl. frontbeklædning, 10 cm bredt. Rechte Blende/Passtück ohne Frontverkleidung, 10 cm breit. Right front adjusting panel without frontcovering, 10 cm width.</p>	H 48 B D/T
V3070	 <p>Dispenserskab, 1 dør højre- eller venstrehængt med spejl, 1 dobbelt dispenser til sæbe og desinfektionsmiddel, 1 servietdispenser. Spender-Schrank, 1 Doppelspender für Seife und Desinfektionsmittel, 1 Handtuchspender, 1 Spiegel, 1 Tür rechts oder links angeschlagen Dispenser cabinet, 1 door right or left, 1 mirror, double dispenser for soap and disinfectant, 1 tissue dispenser.</p>	H 48 B 50 D/T 19
V3071	 <p>Dispenserskab, 1 dør højre- eller venstrehængt med spejl, 1 dobbelt dispenser til sæbe og desinfektionsmiddel, 1 papirrulledispenser. Spender-Schrank, 1 Doppelspender für Seife und Desinfektionsmittel, 1 Papierrollenspender, 1 Spiegel, 1 Tür rechts oder links angeschlagen. Dispenser cabinet, 1 door right or left, 1 mirror, double dispenser for soap and disinfectant, 1 dispenser for roll of paper.</p>	H 48 B 50 D/T 24
V3071B	 <p>Dispenserskab, 1 dør højre- eller venstrehængt med spejl, 2 stk. berøringsfri dispensere til sæbe og desinfektionsmiddel, 1 papirrulledispenser. Spender-Schrank, 2 berührungslose Spender für Seife und Desinfektionsmittel, 1 Papierrollenspender, 1 Spiegel, 1 Tür rechts oder links angeschlagen. Dispenser cabinet, 1 door right or left, 1 mirror, 2 touchless dispensers for soap and disinfectant, 1 dispenser for roll of paper.</p>	H 48 B 50 D/T 24
V3071N	 <p>Dispenserskab, 1 dør højre- eller venstrehængt med spejl, 1 papirrulledispenser. Skabet leveres uden bund. Spender-Schrank, 1 Papierrollenspender, 1 Spiegel, 1 Tür rechts oder links angeschlagen. Der Schrank ist bodenlos. Dispenser cabinet, 1 door right or left, 1 mirror, 1 dispenser for roll of paper. The cabinet is bottomless.</p>	H 48 B 50 D/T 24
V3072	 <p>Dispenserskab, 1 dør højre- eller venstrehængt med spejl, 1 dobbelt dispenser til sæbe og desinfektionsmiddel, 1 dispenser for krus, 1 papirrulledispenser. Spender-Schrank, 1 Doppelspender für Seife und Desinfektionsmittel, 1 Papierrollenspender, 1 Spender für Becher, 1 Spiegel, 1 Tür rechts oder links angeschlagen Dispenser cabinet, 1 door right or left, 1 mirror, double dispenser for soap and disinfectant, 1 dispenser for cups, 1 dispenser for roll of paper.</p>	H 48 B 50 D/T 24

Varenr. Warennr. Article nr.	Beskrivelse / Beschreibung / Description	Mål i cm Mass Measure
V3085	 <p>Hygiejneskab, plads for servietter, 4 x hul for handsker eller mundbind, manuel sæbe/sprit dispenser. Plads for opbevaring af handsker/mundbind/papir, 2 låger, 1 med spejl påmonteret.</p> <p>Hygieneschrank, Platz für Servietten, 4 x Löcher für Handschuhe oder Mundschutz, manueller Seifen- / Alkoholdispenser. Platz für die Aufbewahrung von Handschuhen / Mundschutz / Papier, 2 Türen, 1 mit Spiegel montiert.</p> <p>Hygiene cabinet, space for napkins, 4 x holes for gloves or masks, manual soap / alcohol dispenser. Space for storing gloves / masks / paper, 2 doors, 1 with mirror mounted.</p>	<p>H 88,6</p> <p>B 60</p> <p>D/T 15,3</p>
V3074	 <p>Dispenserskab, 1 dør højre- eller venstrehængt, 1 dobbelt dispenser til sæbe og desinfektionsmiddel, 2 huller for handsker, 1 hul for mundbind.</p> <p>Spender-Schrank, 1 Doppeldispenser für Seife und Desinfektionsmittel, 1 Tür rechts oder links angeschlagen, 2 Löcher für Handschuhe, 1 Loch für Mundschutz.</p> <p>Dispenser cabinet, 1 door right or left, 1 double dispenser for soap and disinfectant, 2 openings for gloves, 1 opening for face masks.</p>	<p>H 48</p> <p>B 50</p> <p>D/T 19</p>
V3075	 <p>Handskedispenser, 2 huller for handsker, 1 hul for mundbind, 1 jalousidør højre- eller venstrehængt.</p> <p>Handschuhspender, 2 Löcher für Handschuhe, 1 Loch für Mundschutz, 1 Rolladentür rechts oder links angeschlagen.</p> <p>Dispenser for gloves, 2 openings for gloves, 1 opening for face masks, 1 roll-front right or left.</p>	<p>H 48</p> <p>B 50</p> <p>D/T 17</p>
V3075-1	 <p>Handskedispenser, 2 huller for handsker, 1 hul for mundbind, 1 jalousidør højre- eller venstrehængt.</p> <p>Handschuhspender, 2 Löcher für Handschuhe, 1 Loch für Mundschutz, 1 Rolladentür rechts oder links angeschlagen.</p> <p>Dispenser for gloves, 2 openings for gloves, 1 opening for face masks, 1 roll-front right or left.</p>	<p>H 48</p> <p>B 50</p> <p>D/T 22</p>
V3080	 <p>Vægskab, 1 vandret jalousidør, 1 hylde.</p> <p>Oberschrank, 1 Einlegeboden, 1 horizontal Rolladentür.</p> <p>Storage cabinet, 1 horisontal roll-front, 1 shelf.</p>	<p>H 48</p> <p>B 50</p> <p>D/T 35</p>
V3081	 <p>Vægskab, 1 lodret jalousidør, 1 hylde.</p> <p>Oberschrank, 1 Einlegeboden, 1 senkrecht Rolladentür.</p> <p>Storage cabinet, 1 vertical roll-front, 1 shelf.</p>	<p>H 48</p> <p>B 50</p> <p>D/T 35</p>
V3082	 <p>Vægskab, 1 vandret jalousidør, 1 hylde.</p> <p>Oberschrank, 1 Einlegeboden, 1 horizontal Rolladentür.</p> <p>Storage cabinet, 1 horisontal roll-front, 1 shelf.</p>	<p>H 48</p> <p>B 60</p> <p>D/T 35</p>
V3083	 <p>Vægskab, 1 lodret jalousidør, 1 hylde.</p> <p>Oberschrank, 1 Einlegeboden, 1 senkrecht Rolladentür.</p> <p>Storage cabinet, 1 vertical roll-front, 1 shelf.</p>	<p>H 48</p> <p>B 60</p> <p>D/T 35</p>
V3084	 <p>Synsprøveskab med magasin for ekstra synstavle. Bagbelyst med LED striplight, 230 volt tilslutning.</p> <p>Sehtest-schrank mit Magazin für Extraboard. Beleuchtet mit LED-Striplight, 230 Volt Anschluss.</p> <p>Vision Test unit with magazine for extra sheet. Backlit with LED striplight, 230 volt connection.</p>	<p>H 64</p> <p>B 40</p> <p>D/T 15</p>



Varenr. Warennr. Article nr.	Beskrivelse / Beschreibung / Description	Mål i cm Mass Measure
Mobilskabe	Fahrbarer Schränke	Mobile cabinets
M3060	 <p>Mobilskab, 6 skuffer 6 cm, 2 skuffer 12 cm. Fahrbarer Schrank, 6 Schubladen 6 cm, 2 Schubladen 12 cm. Mobile cabinet, 6 drawers 6 cm, 2 drawers 12 cm.</p>	<p>H 87,5 B 50 D/T 49</p>
M3060-1	 <p>Mobilskab, 6 skuffer 6 cm, 2 skuffer 12 cm. Fahrbarer Schrank, 6 Schubladen 6 cm, 2 Schubladen 12 cm. Mobile cabinet, 6 drawers 6 cm, 2 drawers 12 cm.</p>	<p>H 92,5 B 50 D/T 49</p>
M3061	 <p>Mobilskab, 5 skuffer 6 cm, 2 skuffer 12 cm, 2 udtræksplader. Fahrbarer Schrank, 5 Schubladen 6 cm, 2 Schubladen 12 cm, 2 Ausziehbare Platten Mobile cabinet, 5 drawers 6 cm, 2 drawers 12 cm, 2 pull-out boards.</p>	<p>H 87,5 B 50 D/T 49</p>
M3061-1	 <p>Mobilskab, 5 skuffer 6 cm, 2 skuffer 12 cm, 2 udtræksplader. Fahrbarer Schrank, 5 Schubladen 6 cm, 2 Schubladen 12 cm, 2 Ausziehbare Platten Mobile cabinet, 5 drawers 6 cm, 2 drawers 12 cm, 2 pull-out boards.</p>	<p>H 92,5 B 50 D/T 49</p>
M3062	 <p>Mobilskab. 6 skuffer 6 cm, 1 skuffe 12 cm. Fahrbarer Schrank, 6 Schubladen 6 cm, 1 Schublade 12 cm. Mobile cabinet, 6 drawers 6 cm, 1 drawer 12 cm.</p>	<p>H 80 B 50 D/T 49</p>
M3063	 <p>Mobilskab, 5 skuffer 6 cm, 1 skuffe 12 cm, 2 udtræksplader. Fahrbarer Schrank, 5 Schubladen 6 cm, 1 Schublade 12 cm, 2 Ausziehbare Platten Mobile cabinet, 5 drawers 6 cm, 1 drawer 12 cm, 2 pull-out boards.</p>	<p>H 80 B 50 D/T 49</p>
M3064	 <p>Mobilskab, 4 skuffer 6 cm, 1 skuffe 12 cm. Fahrbarer Schrank, 4 Schubladen 6 cm, 1 Schublade 12 cm. Mobile cabinet, 4 drawers 6 cm, 1 drawer 12 cm.</p>	<p>H 80 B 50 D/T 49</p>
M3065	 <p>Mobilskab, 3 skuffer 6 cm, 1 skuffe 12 cm, 2 udtræksplader. Fahrbarer Schrank, 3 Schubladen 6 cm, 1 Schublade 12 cm, 2 Ausziehbare Platten Mobile cabinet, 3 drawers 6 cm, 1 drawer 12 cm, 2 pull-out boards.</p>	<p>H 80 B 50 D/T 49</p>
M3066	 <p>Mobilskab. 4 skuffer 6 cm, 1 skuffe 12 cm, 1 forlænget bordplade 82 cm, 1 overhylde 50 cm. Fahrbarer Schrank, 4 Schubladen 6 cm, 1 Schublade 12 cm, 1verlængerte Tischplatte 82 cm, 1 Ablage 50 cm. Mobile cabinet, 4 drawers 6 cm, 1 drawer 12 cm, 1 extended countertop 82 cm, 1 shelf 50 cm.</p>	<p>H 80 B 50/82 D/T 49</p>

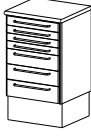
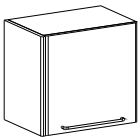
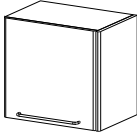
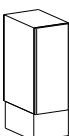
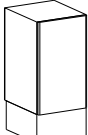
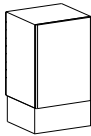
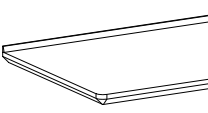
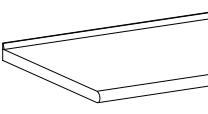
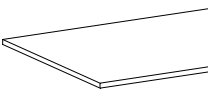

Varenr. Warennr. Article nr.	Beskrivelse / Beschreibung / Description	Mål i cm Mass Measure
M3070	 <p>Mobilskab, 1 vinge til venstre, 6 skuffer 6 cm, 1 skuffe 12 cm, 24 cm højt overskab med 1 låge og 1 åben reol.</p> <p>Fahrbarer Schrank, 6 Schubladen 6 cm, 1 Schublade 12 cm, 1 verlängerte Tischplatte links, 24 cm hoher Oberschrank mit 1 Tür und 1 offenes Regal.</p> <p>Mobile cabinet, 1 left winged table top, 6 drawers 6 cm, 1 drawer 12 cm, 24 cm high upper cabinet with 1 door and 1 open bookcase.</p>	<p>H 76/113</p> <p>B 50/89</p> <p>D/T 54/60</p>
M3070-0	 <p>Mobilskab, 1 vinge til venstre, 6 skuffer 6 cm, 1 skuffe 12 cm.</p> <p>Fahrbarer Schrank, 6 Schubladen 6 cm, 1 Schublade 12 cm. 1 verlängerte Tischplatte links,</p> <p>Mobile cabinet, 1 left winged table top, 6 drawers 6 cm, 1 drawer 12 cm.</p>	<p>H 76</p> <p>B 50/89</p> <p>D/T 54/60</p>
M3071	 <p>Mobilskab, 1 vinge til venstre, 1 vinge til højre, 6 skuffer 6 cm, 1 skuffe 12 cm, 24 cm højt overskab med 1 låge og 1 åben reol.</p> <p>Fahrbarer Schrank, 1 verlängerte Tischplatte links und rechts, 24 cm hoher Oberschrank mit 1 Tür und 1 offenes Regal 6 Schubladen 6 cm, 1 Schublade 12 cm,</p> <p>Mobile cabinet, 1 left winged table top, 1 right winged table top, 6 drawers 6 cm, 1 drawer 12 cm, 24 cm high upper cabinet with 1 door and 1 open bookcase.</p>	<p>H 76/113</p> <p>B 50/124</p> <p>D/T 54/60</p>
M3071-0	 <p>Mobilskab, 1 vinge til venstre, 1 vinge til højre, 6 skuffer 6 cm, 1 skuffe 12 cm.</p> <p>Fahrbarer Schrank, 1 verlängerte Tischplatte links und rechts, 6 Schubladen 6 cm , 1 Schublade 12 cm.</p> <p>Mobile cabinet, 1 left winged table top, 1 right winged table top, 6 drawers 6 cm, 1 drawer 12 cm.</p>	<p>H 76</p> <p>B 50/124</p> <p>D/T 54/60</p>
M3072	 <p>Mobilskab, 1 vinge til venstre, 6 skuffer 6 cm, 1 skuffe 12 cm, opbevaringsskab med plads til 8 bakker m. låg, 24 cm højt overskab med 2 låger og 1 åben reol.</p> <p>Fahrbarer Schrank, 6 Schubladen 6 cm, 1 Schublade 12 cm, 1 Schrank für 8 Trays mit Deckel und 1 einschiebbare Tür, 1 verlängerte Tischplatte links, 24 cm hoher Oberschrank mit 2 Türen und 1 offenes Regal</p> <p>Mobile cabinet, 1 left winged table top, 6 drawers 6 cm, 1 drawer 12 cm, storage cabinet with room for 8 trays, 24 cm high upper cabinet with 2 doors and 1 open bookcase.</p>	<p>H 76/113</p> <p>B 80/119</p> <p>D/T 54/60</p>
M3072-0	 <p>Mobilskab, 1 vinge til venstre, 1 vinge til højre, 6 skuffer 6 cm, 1 skuffe 12 cm, opbevaringsskab med plads til 8 bakker m. låg.</p> <p>Fahrbarer Schrank, 6 Schubladen 6 cm, 1 Schublade 12 cm, 1 Schrank für 8 Trays mit Deckel und 1 einschiebbare Tür, 1 verlängerte Tischplatte links</p> <p>Mobile cabinet, 1 left winged table top, 1 right winged table top, 6 drawers 6 cm, 1 drawer 12 cm, storage cabinet with room for 8 trays.</p>	<p>H 76</p> <p>B 80/119</p> <p>D/T 54/60</p>
M3073	 <p>Mobilskab, 1 vinge til venstre, 1 vinge til højre, 6 skuffer 6 cm, 1 skuffe 12 cm, opbevaringsskab med plads til 8 bakker m. låg, 24 cm højt overskab med 2 låger og 1 åben reol.</p> <p>Fahrbarer Schrank, 6 Schubladen 6 cm, 1 Schublade 12 cm, 1 Schrank für 8 Trays mit Deckel und 1 einschiebbare Tür, 1 verlängerte Tischplatte links und rechts, 24 cm hoher Oberschrank mit 2 Türen und 1 offenes Regal</p> <p>Mobile cabinet, 1 left winged table top, 1 right winged table top, 6 drawers 6 cm, 1 drawer 12 cm, storage cabinet with room for 8 trays, 24 cm high upper cabinet with 2 doors and 1 open bookcase.</p>	<p>H 76/113</p> <p>B 80/154</p> <p>D/T 54/60</p>

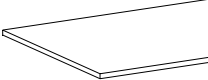
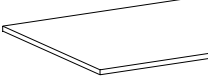
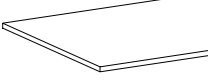
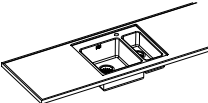
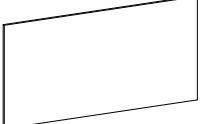
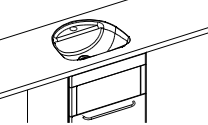
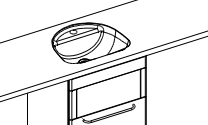
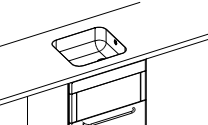
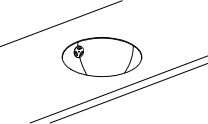

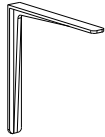

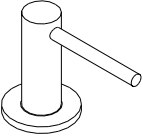
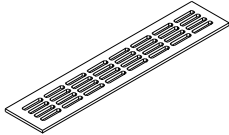
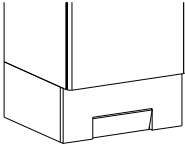
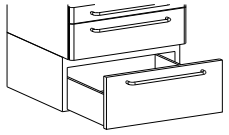
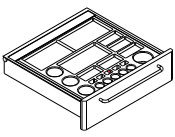
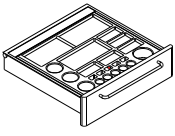
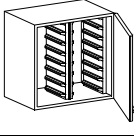
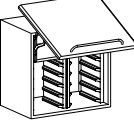
Varenr. Warennr. Article nr.	Beskrivelse / Beschreibung / Description	Mål i cm Mass Measure
M3073-0	 <p>Mobilskab, 1 vinge til venstre, 1 vinge til højre, 6 skuffer 6 cm, 1 skuffe 12 cm, opbevaringsskab med plads til 8 bakker m. låg. Fahrbarer Schrank, 6 Schubladen 6 cm, 1 Schublade 12 cm, 1 Schrank für 8 Trays mit Deckel und 1 einschiebbare Tür, 1 verlängerte Tischplatte links und rechts Mobile cabinet, 1 left winged table top, 1 right winged table top, 6 drawers 6 cm, 1 drawer 12 cm, storage cabinet with room for 8 trays.</p>	<p>H 76 B 80/154 D/T 54/60</p>
M3076	 <p>Mobilskab, 6 skuffer 6 cm, 1 skuffe 12 cm, 24 cm højt overskab med 1 låge og 1 åben reol. Fahrbarer Schrank, 6 Schubladen 6 cm, 1 Schublade 12 cm, 24 cm hoher Oberschrank mit 1 Tür und 1 offenes Regal Mobile cabinet, 6 drawers 6 cm, 1 drawer 12 cm, 24 cm high upper cabinet with 1 door and 1 open bookcase.</p>	<p>H 76/113 B 54 D/T 54</p>
M3076-0	 <p>Mobilskab, 6 skuffer 6 cm, 1 skuffe 12 cm. Fahrbarer Schrank, 6 Schubladen 6 cm, 2 Schubladen 12 cm. Mobile cabinet, 6 drawers 6 cm, 1 drawer 12 cm.</p>	<p>H 76 B 54 D/T 54</p>
M3078	 <p>EDB rullebord med elektrisk hæve/sænke funktion fra 74-124 cm. Farve: Alu Computerwagen mit elektrischer Hebe- / Senkfunktion von 74-124 cm. Farbe: Alu Computer trolley electricframe heightadjustable from 74-124 cm. Colour : Alu</p>	<p>H H/S B 80 D/T 49</p>

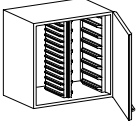
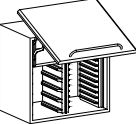
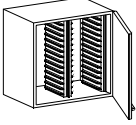
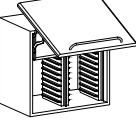

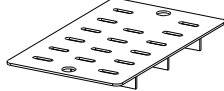
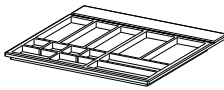
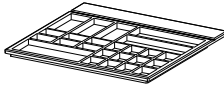
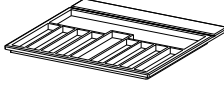
Varenr. Warennr. Article nr.	Beskrivelse / Beschreibung / Description	Mål i cm Mass Measure
Tilbehør	Zubehör	Accessories
T3001	 <p>Venstre sidebeklædning, tykkelse 2 cm. Seitenverkleidung 2 cm / links für Unterschränke Left end panel, 2 cm.</p>	<p>H 67,2 B 2 D/T 47</p>
T3002	 <p>Højre sidebeklædning, tykkelse 2 cm. Seitenverkleidung 2 cm / rechts für Unterschränke Right end panel, 2 cm.</p>	<p>H 67,2 B 2 D/T 47</p>
T3005	 <p>Venstre sidebeklædning, tykkelse 2 cm. Seitenverkleidung 2 cm / links für Oberschränke Left end panel, 2 cm.</p>	<p>H 48 B 2 D/T 35</p>
T3006	 <p>Højre sidebeklædning, tykkelse 2 cm. Seitenverkleidung 2 cm / rechts für Oberschränke, Right end panel, 2 cm.</p>	<p>H 48 B 2 D/T 35</p>
T3007	 <p>Bagsidebeklædning. Rückwandverkleidung für Unterschränke Backcovering.</p>	<p>H 67,2 B 30 D/T 2</p>
T3008	 <p>Bagsidebeklædning. Rückwandverkleidung für Unterschränke Backcovering.</p>	<p>H 67,2 B 40 D/T 2</p>
T3009	 <p>Bagsidebeklædning. Rückwandverkleidung für Unterschränke Backcovering.</p>	<p>H 67,2 B 50 D/T 2</p>
T3010	 <p>Bordplade MDF, pr. 10 cm. Tischplatte MDF, pro. 10 cm. Countertop MDF, per. 10 cm.</p>	<p>H B D/T 49</p>
T3011	 <p>Bordplade IMP, pr. 10 cm. Tischplatte IMP, pro. 10 cm. Countertop IMP, per. 10 cm.</p>	<p>H B D/T 49</p>
T3013	 <p>Bordplade i 12 mm kompaktlaminat. Farve 1025 Hvid. Pr. 10 cm. Tischplatte in 12 mm Kompaktlaminat. Farbe 1025 Weiss. Pro 10 cm. Countertop in 12 mm Compactlaminat. Color 1025 White. Per 10 cm.</p>	<p>H B D/T 49</p>

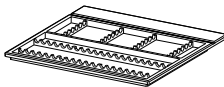

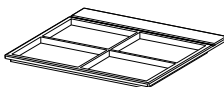
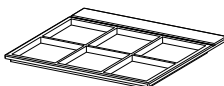
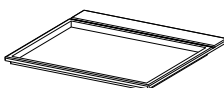
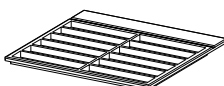
Varenr. Warenr. Article nr.	Beskrivelse / Beschreibung / Description	Mål i cm Mass Measure
T3013-1	 <p>Bordplade i 12 mm kompaktlaminat. Farve 1025 Hvid. Pr. 10 cm. Tischplatte in 12 mm Kompaktlaminat. Farbe 1025 Weiss. Pro 10 cm. Countertop in 12 mm Compactlaminat. Color 1025 White. Per 10 cm.</p>	H B D/T 60
T3014	 <p>Bordplade, 16 mm tykkelse. Tischplatte, 16 mm dicke. Countertop, 16 mm thickness.</p>	H B D/T 49
T3014-1	 <p>Bordplade, 16 mm tykkelse. Tischplatte, 16 mm dicke. Countertop, 16 mm thickness.</p>	H B D/T 60
T3015	<p>Bordplade/Vaske i komposit. EFTER TILBUD. Tischplatten/Waschbecken auf komposit. AUF NACHFRAGE. Tabletops/Sinks in composite. ACCORDING TO OFFER.</p>	H B D/T
T3015-1	 <p>Rustfri stålbordplade. EFTER TILBUD. Nirosta Tischplatte. AUF NACHFRAGE. Stainless steel worktop. ACCORDING TO OFFER.</p>	H B D/T
T3016	 <p>Vægbeklædning laminat, pr. 10 cm. Wandverkleidung Laminat, pro. 10 cm. Wall panel laminate, per. 10 cm.</p>	H 48 B D/T 1,6
T3017	 <p>Porcelænsvask uden overløb, uden bundventil, underlimet i plan med bordplade. Porzellan-Waschbecken ohne Überlauf, ohne Bodenventil, untergeleimt. Porcelain sink without overflow, without strainer - sunken.</p>	H B D/T
T3017-1	 <p>Porcelænsvask med overløb, uden bundventil, underlimet i plan med bordplade. Porzellan-Waschbecken mit Überlauf, ohne Bodenventil, untergeleimt. Porcelain sink with overflow, without strainer - sunken.</p>	H B D/T
T3018	 <p>Stålvask, underlimet, 34x30 cm. Stahlwaschbecken, untergeleimt, 34x30 cm. Steel sink, sunken, 34x30 cm.</p>	H B D/T
T3019-2	 <p>Håndvask i rustfrit stål - Højglans. Ø 250 mm. Rostfrei Stahl-Waschbecken - Hochglanz. Ø 250 mm. Stainless steel sink - polished. Ø 250 mm.</p>	H B D/T

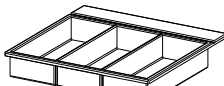
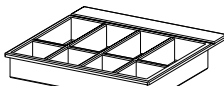
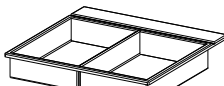

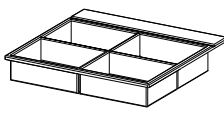
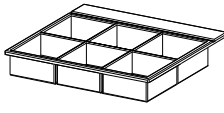
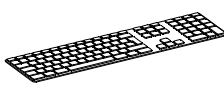
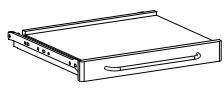
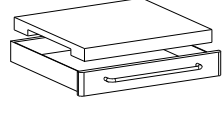
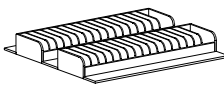
Varenr. Warennr. Article nr.	Beskrivelse / Beschreibung / Description	Mål i cm Mass Measure
T3020	 <p>Vægkonsol. Wand / Winkelbeschlag Bracket to support extended countertop.</p>	H B D/T
T3021	 <p>Aluliste, 30x30 mm. Aluleiste, 30x30 mm. Aluminum bracket, 30x30 mm.</p>	H B D/T
T3023	 <p>VOLA sæbedispenser, krom. VOLA Seifenspender, Chrom. VOLA soap dispenser, chrom.</p>	H B D/T
T3024	 <p>Udluftningsgitter, 8x40cm. Lüftungsgitter 8x40cm. Ventilation grille, 8x40cm.</p>	H B D/T
T3025-1	 <p>Eletromagnetisk vandstyring uden magnetventiler. Elektromagnetische Wassesteuerung ohne Magnetventilen. Foot operated eletromagnetic faucet without magnetic valves.</p>	H B D/T
T3026	 <p>Sokkelskuffe. Sockelschublade Plinth-drawer.</p>	H B D/T
T3031	 <p>Specialskuffe komplet, incl. glas og borstander. Spezialschublade komplett mit Glass und Bohrstander Special drawer, complete with glass and drill standard.</p>	H B D/T
T3031-1	 <p>Specialskuffe, kun udstyret med borstander. Spezialschublade nur für Bohrerstander Special drawer, only with drill standard.</p>	H B D/T
T3034	 <p>Indsats for 14 bakker m/låg Einsatz für 14 Normtrays mit Deckel. Plastic liner for 14 instrument trays with cover.</p>	H B 50 D/T
T3034-2	 <p>Indsats for 10 bakker m/låg. Einsatz für 10 Normtrays mit Deckel. Plastic liner for 10 instrument trays with cover.</p>	H B 50 D/T

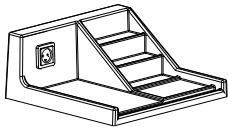
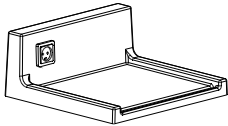

Varenr. Warennr. Article nr.	Beskrivelse / Beschreibung / Description	Mål i cm Mass Measure
T3035	 <p>Indsats for 15 bakker u/låg og 7 bakker m/ låg. Einsatz für 15 Normtrays ohne Deckel , 7 Normtrays mit Deckel. Plastic liner for 15 instrument trays with out cover and 7 instument trays with cover.</p>	H B 50 D/T
T3035-2	 <p>Indsats for 10 bakker u/låg og 5 bakker m/låg. Einsatz für 10 Trays ohne Deckel, 5 Trays mit Deckel. Plastic liner for 10 trays without cover, 5 trays with cover.</p>	H B 50 D/T
T3036	 <p>Indsats for 30 bakker u/låg. Einsatz für 30 Normtrays ohne Deckel. Plastic liner for 30 instrument trays without cover.</p>	H B 50 D/T
T3036-2	 <p>Indsats for 20 bakker u/låg. Einsatz für 20 Trays ohne Deckel. Plastic liner for 20 trays without cover.</p>	H B 50 D/T
T3037	 <p>Affaldskurv. Abfallkorb. Basket for waste.</p>	H B D/T
T3038	<p>1 sæt opalglas bestående af skåle, kappeglas og dispensere. 1 Opalglas Schale, Kappengläser, Pellettenausgabegeräte, Opalglasschalen und Speicher 1 set of opalglass, consist of opal glass cups, cap lasses and depositories.</p>	H B D/T
T3040	 <p>Mundskeindsats til varenr. T3053. Mundöffellocheinsatz für T3053. White perforated plate for impression trays for T3053.</p>	H 3 B 18,6 D/T 30,7
T3041	 <p>Indsats til 6 cm skuffe. Schubladeneinsatz für 6 cm Schubladen. Inserts for 6 cm drawer.</p>	H 2,3 B 43,5 D/T 42
T3042	 <p>Indsats til 6 cm skuffe. Schubladeneinsatz für 6 cm Schubladen. Inserts for 6 cm drawer.</p>	H 2,3 B 43,5 D/T 42
T3043	 <p>Indsats til 6 cm skuffe. Schubladeneinsatz für 6 cm Schubladen. Inserts for 6 cm drawer.</p>	H 2,3 B 43,5 D/T 42

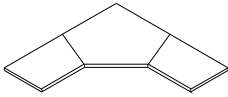
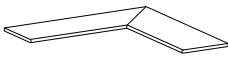
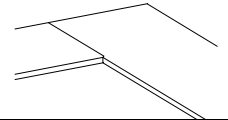
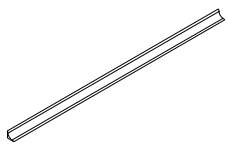
Varenr. Warennr. Article nr.	Beskrivelse / Beschreibung / Description	Mål i cm Mass Measure
T3044	<p>Indsats til 6 cm skuffe.</p>  <p>Schubladeneinsatz für 6 cm Schubladen.</p> <p>Inserts for 6 cm drawer.</p>	<p>H 2,3 B 43,5 D/T 42</p>
T3045	<p>Indsats til 6 cm skuffe.</p>  <p>Schubladeneinsatz für 6 cm Schubladen.</p> <p>Inserts for 6 cm drawer.</p>	<p>H 2,3 B 43,5 D/T 42</p>
T3046	<p>Indsats til 6 cm skuffe.</p>  <p>Schubladeneinsatz für 6 cm Schubladen.</p> <p>Inserts for 6 cm drawer.</p>	<p>H 2,3 B 43,5 D/T 42</p>
T3047	<p>Indsats til 6 cm skuffe.</p>  <p>Schubladeneinsatz für 6 cm Schubladen.</p> <p>Inserts for 6 cm drawer.</p>	<p>H 2,3 B 43,5 D/T 42</p>
T3048	<p>Indsats til 6 cm skuffe.</p>  <p>Schubladeneinsatz für 6 cm Schubladen.</p> <p>Inserts for 6 cm drawer.</p>	<p>H 2,3 B 43,5 D/T 42</p>
T3049	<p>Indsats til 6 cm skuffe.</p>  <p>Schubladeneinsatz für 6 cm Schubladen.</p> <p>Inserts for 6 cm drawer.</p>	<p>H 2,3 B 43,5 D/T 42</p>
I203	<p>Gummimåtte til skuffe.</p>  <p>Gummimatte für Schublade</p> <p>Rubber mat for drawers.</p>	<p>H B D/T</p>
T3051	<p>Indsats til 12 cm skuffe.</p>  <p>Schubladeneinsatz für 12 cm Schubladen.</p> <p>Inserts for 12 cm drawer.</p>	<p>H 7,3 B 43,5 D/T 42</p>
T3052	<p>Indsats til 12 cm skuffe.</p>  <p>Schubladeneinsatz für 12 cm Schubladen.</p> <p>Inserts for 12 cm drawer.</p>	<p>H 7,3 B 43,5 D/T 42</p>
T3053	<p>Indsats til 12 cm skuffe.</p>  <p>Schubladeneinsatz für 12 cm Schubladen.</p> <p>Inserts for 12 cm drawer.</p>	<p>H 7,3 B 43,5 D/T 42</p>

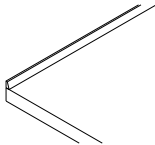
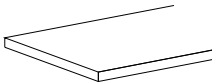
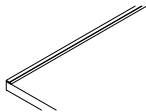

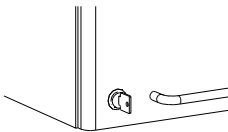
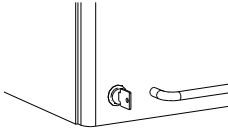
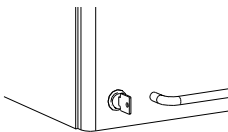
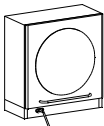

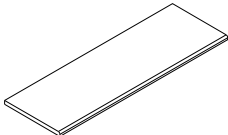
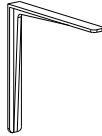
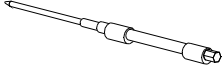
Varenr. Warennr. Article nr.	Beskrivelse / Beschreibung / Description	Mål i cm Mass Measure
T3054	<p>Indsats til 12 cm skuffe.</p>  <p>Schubladeneinsatz für 12 cm Schubladen.</p> <p>Inserts for 12 cm drawer.</p>	<p>H 7,3 B 43,5 D/T 42</p>
T3055	<p>Indsats til 12 cm skuffe.</p>  <p>Schubladeneinsatz für 12 cm Schubladen.</p> <p>Inserts for 12 cm drawer.</p>	<p>H 7,3 B 43,5 D/T 42</p>
T3056	<p>Indsats til 12 cm skuffe.</p>  <p>Schubladeneinsatz für 12 cm Schubladen.</p> <p>Inserts for 12 cm drawer.</p>	<p>H 7,3 B 43,5 D/T 42</p>
T3057	<p>Udfræsning for tastatur. Oplys udskæringsmål.</p>  <p>Einbauen von Tastatur in Schublade. Bitte Maß angeben.</p> <p>Milling for built-in keyboard. Please specify measurements.</p>	<p>H B D/T</p>
T3058	<p>Tastatur-udtræk i skuffeskab.</p>  <p>Ausziehbare Platte für die Tastatur, im Schubladenschrank eingebaut</p> <p>Pull-out plate for keyboard, built-in cabinet for drawers.</p>	<p>H B D/T 35</p>
T3059	<p>Skriveplade.</p>  <p>Schreibplatte für Schubladen.</p> <p>Pull out desk for drawers.</p>	<p>H B D/T</p>
T3060	<p>Indsats til ortodonti-tænger</p>  <p>Einsatz für orthopädische Zange</p> <p>Insert for orthodontic pliers</p>	<p>H B D/T</p>
T3061	<p>Lysliste, pr. 10 cm.</p>  <p>Lichtleiste, pro. 10 cm.</p> <p>Light reflector for indirect lighting, per. 10 cm.</p>	<p>H B D/T</p>
T3063-2	<p>LED spot til indbygning. 2,6 Watt.</p>  <p>LED Spot zum Einbauen. 2,6 Watt.</p> <p>Building in LED spot. 2,6 Watt.</p>	<p>H B D/T</p>
T3065	<p>Indsats, u/stikkontakt.</p>  <p>Einsatz ohne Steckdose.</p> <p>Inserts without socket.</p>	<p>H B D/T</p>

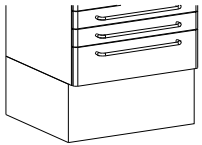
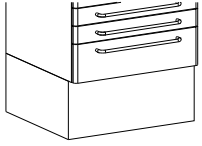
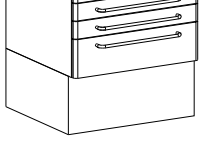
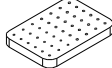
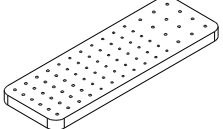

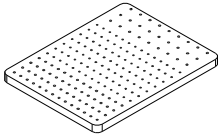
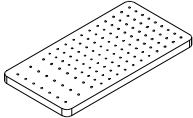
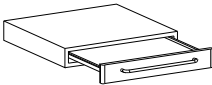
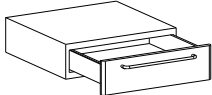
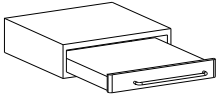
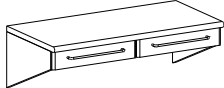
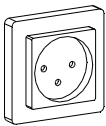
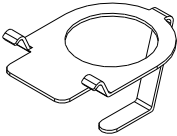
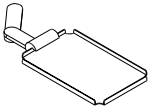

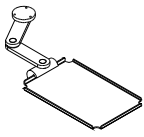
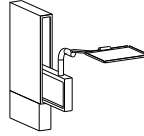
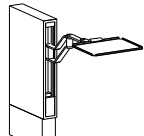
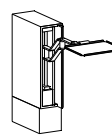
Varenr. Warennr. Article nr.	Beskrivelse / Beschreibung / Description	Mål i cm Mass Measure
T3067	 <p>Indsats m/stikkontakt. Einsatz mit Steckdose. Inserts with socket.</p>	H B D/T
T3069	 <p>Universalindsats med stikkontakt til varenr. S3016. Universateinsatz für S3016 mit Steckdose Universal insert with plug for S3016.</p>	H B D/T
T3070	 <p>Plade for indbygning af halogenspots i vægskabe, pr. 10 cm. Einbauplatte für Halogen Spots in Oberehränken, pro 10 cm. Plate for built-in halogenspots wall cabinets, per 10 cm.</p>	H B D/T
T3071	 <p>Specialskæring hjørnebordplade. Spezialgeschnittene Ecktischplatte. Special cutting of countertop.</p>	H B D/T
T3072	 <p>Bordpladesamling. Tischplatte sammlung. Countertop joint.</p>	H B D/T
T3073	 <p>Bordpladesamling. Tischplatte Sammlung. Countertop joint.</p>	H B D/T
T3076	 <p>Vægttilslutningsliste, pr. m. Wandanschlußleiste, pro m. Moulding, per m.</p>	H B D/T
T3077	<p>Affaldsposer, 1 rulle a 50 stk. (30 liter pr. pose). Abfallbeutel, 1 Rolle mit 50 Stück (30 L. pro. Beutel). Waste disposal bags, 1 roll of 50 pieces each. (30 L. per. Bag).</p>	H B D/T
T3077-1	<p>Affaldsposer, v/minimum 10 ruller. (30 liter pr. pose). Pr. rl. Abfallbeutel, v/minimum 10 Rollen (30 L. pro. Beutel). Pr. rl. Waste disposal bags, w/minimum 10 rolls. (30 L. per. Bag). Pr. rl.</p>	H B D/T
T3077-2	<p>Affaldsposer, v/minimum 50 ruller. (30 liter pr. pose). Pr. rl. Abfallbeutel, v/minimum 50 Rollen (30 L. pro. Beutel). Pr. rl. Waste disposal bags, w/minimum 50 rolls. (30 L. per. Bag). Pr. rl.</p>	H B D/T

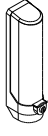
Varenr. Warennr. Article nr.	Beskrivelse / Beschreibung / Description	Mål i cm Mass Measure
T3078	 <p>Alu vægttilslutningsliste, pr. m. Alu Wandanschlussleiste, pro m. Alu moulding, per. m.</p>	H B D/T
T3078-1	 <p>Aluminium forkantliste, Aluminium-Vorderkantenliste, Aluminum front edge list,</p>	H B D/T
T3079	 <p>ALP liste for vægbeklædning, pr. m. ALP leiste für Wandverkleidung, pro m. ALP moulding, per. m.</p>	H B D/T
T3080	 <p>Hyldebærer i rustfri stål look. Sæt á 2 stk. Regalträger Edeltstahloptik. 2 stück. Shelf holder stainl steel look. 2 pcs.</p>	H B D/T
T3081	 <p>Lås til skab, unikke nøgler. Tür Schloss für den Schrank, einzigartig Schlüsseln. Lock mounted in door, unique keys.</p>	H B D/T
T3081-1	 <p>Lås til skab, ens nøgler. Nøgle nr. 1 Tür Schloss für den Schrank, gleiche Schlüsseln. Schlüssel nr. 1 Lock mounted in door, identical keys. Key nr. 1</p>	H B D/T
T3081-2	 <p>Ekstra nøgler til T3081 Zusätzliche Schlüssel für T3081 Extra keys for T3081</p>	H B D/T
T3082	<p>Ekstra hylde i vægskab. Zusätzlicher Einlegeboden für Wandschränke Supplementary shelf in wall cabinets.</p>	H B D/T
T3083	<p>Ekstra hylde i underskab. Zusätzlicher Einlegeboden im Unterschrank. Supplementary shelf in floor cabinets.</p>	H B D/T
T3084	 <p>Rundt spejl. Runden Spiegel. Round mirror.</p>	H B D/T

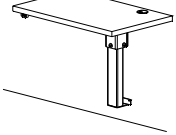
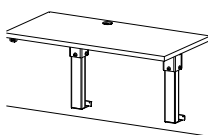
Varenr. Warennr. Article nr.	Beskrivelse / Beschreibung / Description	Mål i cm Mass Measure
T3085	<p>Glashylde.</p> <p>Glasseinlegeboden.</p> <p>Glass shelf.</p>	<p>H</p> <p>B</p> <p>D/T</p>
T3086	 <p>Laminathylde med afrundet forkant, pr. 10 cm.</p> <p>Laminatplatte mit abgerundeter Vorderkante, pro. 10 cm.</p> <p>Shelf for mounting on wall, per. 10 cm.</p>	<p>H</p> <p>B</p> <p>D/T 33</p>
T3087	 <p>Hyldeknægte pr. stk.</p> <p>Wand / Winkelbeschlag pro Stück.</p> <p>Bracket, each.</p>	<p>H</p> <p>B</p> <p>D/T</p>
I645	 <p>Skjult hyldebærer.</p> <p>Versteckt Regalträger.</p> <p>Hidden shelf carrier.</p>	<p>H</p> <p>B</p> <p>D/T</p>
T3089	 <p>Ophængsbeslag for hylde, pr. m.</p> <p>Hängervorrichungebeslag für Einlegeböden, pro m.</p> <p>Shelf fittings, per m.</p>	<p>H</p> <p>B</p> <p>D/T</p>
T3090	 <p>Sokkelbeklædning standard, melamin, pr. m.</p> <p>Sockelverkleidung standard, melamin, pro m.</p> <p>Plinth panel standard, melamin, per m.</p>	<p>H</p> <p>B</p> <p>D/T</p>
T3091	 <p>Sokkelbeklædning Laminat, pr. m.</p> <p>Sockelverkleidung Laminat, pro m.</p> <p>Plinth panel Laminat, per m.</p>	<p>H</p> <p>B</p> <p>D/T</p>
T3092	 <p>Sokkelbeklædning alu., pr. m.</p> <p>Sockelverkleidung Alu, pro m.</p> <p>Plinth panel of aluminium laminate, per m.</p>	<p>H</p> <p>B</p> <p>D/T</p>
T3094	 <p>Borstander (indsats T3045)</p> <p>Bohrer Ständer (Einsatz T3045)</p> <p>Drill stand (inserts T3045)</p>	<p>H</p> <p>B 9,5</p> <p>D/T 6,7</p>
T3095	 <p>Borstander (indsats T3045)</p> <p>Bohrer Ständer (Einsatz T3045)</p> <p>Drill stand (inserts T3045)</p>	<p>H</p> <p>B 19,8</p> <p>D/T 6,7</p>

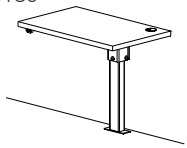
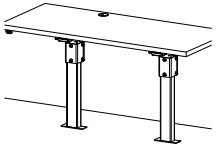
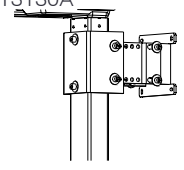
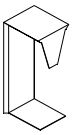
Varenr. Warennr. Article nr.	Beskrivelse / Beschreibung / Description	Mål i cm Mass Measure
T3096	 <p>Borstander (indsats T3046) Bohrer Ständer (Einsatz T3046) Drill stand (inserts T3046)</p>	<p>H</p> <p>B 19,4</p> <p>D/T 15</p>
T3097	 <p>Borstander, (indsats T3031) Bohrerständer (Einsatz T3031) Drill standard (insert T3031)</p>	<p>H</p> <p>B 20,8</p> <p>D/T 10,6</p>
T3100	 <p>6 cm skuffe i kabinet. 6 cm Schublade mit Korpus. 6 cm drawer in open space.</p>	<p>H 6</p> <p>B 50</p> <p>D/T 47</p>
T3100-1	 <p>12 cm skuffe i kabinet. 12 cm Schublade mit Korpus. 12 cm drawer in open space.</p>	<p>H 12</p> <p>B 50</p> <p>D/T 47</p>
T3101	 <p>Skriveudtræksplade i kabinet. Ausziehbare Schreibplatte mit Korpus. Pull-out desk.</p>	<p>H 12</p> <p>B 50</p> <p>D/T 47</p>
T3106	 <p>Skrivepult, 2 skuffer 6 cm. Schreibplatte, 2 Schubladen 6 cm. Desk, 2 drawers 6 cm.</p>	<p>H</p> <p>B 100</p> <p>D/T 49</p>
T3110	 <p>Stikkontakt indbygget. Steckdose eingebaut. Built-in socket.</p>	<p>H</p> <p>B</p> <p>D/T</p>
T3115	<p>Tillæg for forberedelse til sug (varenr. S3015). Aufschlag zu S3015 für Vorbereitung des Saugers Supplement to S3015 for preparation for suck.</p>	<p>H</p> <p>B</p> <p>D/T</p>
T3122	 <p>Alu krusholder. Alu Halter für Becher. Alu holder for cups.</p>	<p>H</p> <p>B</p> <p>D/T</p>
T3123	 <p>Håndinstrumentbord til montering i bordplade. Handinstrument Tisch zum Einbau in Arbeitsplatte. Hand instrument table for mounting in countertop.</p>	<p>H</p> <p>B</p> <p>D/T</p>

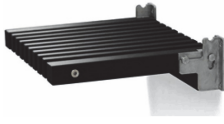

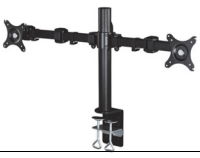
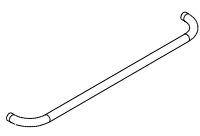
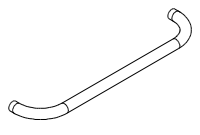

Varenr. Warennr. Article nr.	Beskrivelse / Beschreibung / Description	Mål i cm Mass Measure
T3123-1	 <p>Håndinstrumentbord til montering under bordplade. Handinstrument Tisch zum Einbau unter der Tischplatte Hand instrument table for mounting under the tabletop.</p>	H B D/T
T3124	 <p>Håndinstrumentbord monteret i 10 cm bredt skab. Med stor aluminiumsbakke. Handinstrumententisch im Schrank eingebaut, 10 cm breit. Mit großer Aluminium Tray. Hand instrument table mounted 10 cm width cabinet. With large aluminium tray.</p>	H 67,2 B 10 D/T 45
T3125	 <p>Højdejusterbart håndinstrumentbord monteret i 10 cm bredt skab. (63-100 cm). Med stor aluminiumsbakke. Höhenverstellbarer Handinstrumententisch im Schrank eingebaut 10 cm breit. (63-100 cm). Mit großer Aluminium Tray. Height adjustable hand instrument table mounted in 10 cm width cabinet. (63-100 cm). With large aluminium tray.</p>	H 67,2 B 10 D/T 45
T3125-1	 <p>Højdejusterbart håndinstrumentbord monteret i 20 cm bredt skab. (63-100 cm). 1 dør højre- eller venstrehængt. Med stor aluminiumsbakke. Höhenverstellbarer Handinstrumententisch im Schrank eingebaut 20 cm breit. (63-100 cm). 1 Tür rechts oder links angeschlagen. Mit großer Aluminium Tray. Height adjustable hand instrument table mounted in 20 cm width cabinet. (63-100 cm). 1 door right or left. With large aluminium tray.</p>	H 67,2 B 20 D/T 47
T3126	 <p>Flasketræppe. Flaschentreppe. Staircase for bottles.</p>	H 17 B 22 D/T 23
T3127	 <p>Dispenser for krus. Til montering på væg, eller indbygning i skab. Spender für Becher im Schrank oder Wand Anbau Dispenser for cups. For wall-mounting or built-in cabinets.</p>	H 40 B D/T
T3128	 <p>Ombbygning af dobbelt dispenser for sæbe og desinfektionsmiddel. Umbauen von Doppelspender für Seife und Desinfektionsmittel. Conversion of double dispenser for soap and disinfectant.</p>	H B D/T
T3129	 <p>1-søjlet bordstel, højdejusterbar 68-133 cm. For vægmontering. Farve: Lakeret som aluminium. 1-Säule Tischrahmen höhen verstellbar 68-133 cm. Für Wandmontage. Farbe: Alu 1-columned table frame heightadjustable 68-133 cm. For wall mounting. Color: Alu.</p>	H 68-133 B D/T
T3129-1	 <p>2-søjlet bordstel, højdejusterbar 68-133 cm. For vægmontering. Farve: Lakeret som aluminium. 2-Säule Tischrahmen höhenverstellbar 68-133 cm. Für Wandmontage. Farbe: Alu. 2-columned table frame heightadjustable 68-133 cm. For wall mounting. Color: Alu.</p>	H 68-133 B D/T

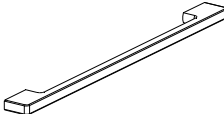
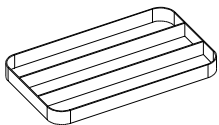
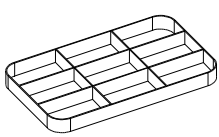
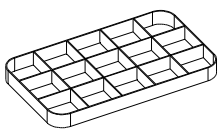
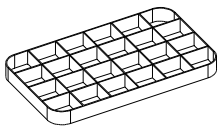
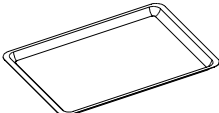
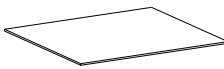
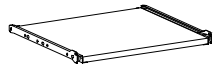
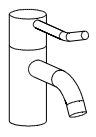
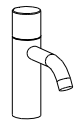
Varenr. Warennr. Article nr.	Beskrivelse / Beschreibung / Description	Mål i cm Mass Measure
T3130	 <p>1-søjlet bordstel, højdejusterbar 68-118 cm. Farve: Lakeret som aluminium. 1-Säule Tischrahmen höhen verstellbar 68-118 cm. Farbe: Alu. 1-columned table frame heightadjustable 68-118 cm. Color: Alu.</p>	H 68-118 B D/T
T3130-1	 <p>2-søjlet bordstel, højdejusterbar 68-118 cm. Farve: Lakeret som aluminium. 2-Säule Tischrahmen höhenverstellbar 68-118 cm. Farbe: Alu. 2-columned table frame heightadjustable 68-118 cm. Color: Alu.</p>	H 68-118 B D/T
T3130A	 <p>Justérbart adapterbeslag. Gør det muligt at kompensere for kabelkanal på væggen. Kun til gulvmonteret søjle. Farve: Lakeret som aluminium. Adapter. Ermöglicht den Ausgleich von Kabelkanal an der Wand. Nur für bodenmontierte Säule. Adjustable adapter bracket. Makes it possible to compensate for cable ducting on the wall. Only for floormounted column.</p>	H B D/T
T3131	 <p>PC-ophæng, Sølv-grå. CPU-Halter, Silber-Grau. CPU Holder, Silver-Grey</p>	H B D/T
T3132	 <p>EDB-arm, vægmonteret. Max udtræk 140 cm. EDV-Arm für Wandmontage. Maximale Auszug 140 cm. Computer arm, wall mounted. Maximum extension 140 cm.</p>	H B D/T
T3133	 <p>Klapstol til montering på væg Klappstuhl für Wandmontage Folding chair for wall mounting</p>	H 10 B 38,5 D/T 31
T3134-1	 <p>Skærmholder for 1 skærm. Monitorarm für 1 Monitor. Monitor arm for 1 monitor.</p>	H B D/T
T3134-2	 <p>Skærmholder for 2 skærme. Monitorarm für 2 Monitors. Monitor arm for 2 monitors.</p>	H B D/T
T3135	 <p>Aluminium greb, 320 mm. Aluminium Griff 320 mm. Aluminum handle, 320 mm.</p>	H B D/T
T3136	 <p>Aluminium greb, 192 mm. Aluminium Griff 192 mm. Aluminum handle, 192 mm.</p>	H B D/T

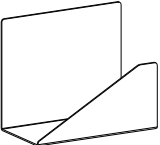
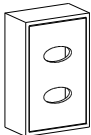
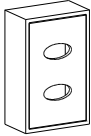
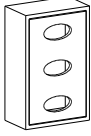
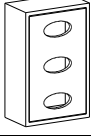
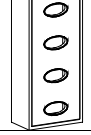
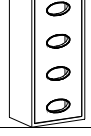

Varenr. Warennr. Article nr.	Beskrivelse / Beschreibung / Description	Mål i cm Mass Measure
T3138	 <p>Greb, 192 mm C+ Krom Griffe, 192 mm C+ Chrom Handle, 192 mm C+ Chrome</p>	H B D/T
T3139	 <p>Greb, 192 mm C+ Alu Griffe, 192 mm C+ Alu Handle, 192 mm C+ Alu</p>	H B D/T
T3140	 <p>Tillæg for farvede greb. Aufschlag für farbige Griffe. Additional price for coloured handle.</p>	H B D/T
T3143	 <p>Greb, 160 mm POOL, Krom Griffe, 160 mm POOL, Chrom Handle, 160 mm POOL, Chrome</p>	H B D/T
T3144	 <p>Greb, 224 mm POOL, Krom Griffe, 224 mm POOL, Chrom Handle, 224 mm POOL, Chrome</p>	H B D/T
T3145	 <p>Greb, 160 mm POOL, børstet stål. Griffe, 160 mm POOL, Stahl gebürstet. Handle, 160 mm POOL, brushed steel.</p>	H B D/T
T3146	 <p>Greb, 224 mm POOL, børstet stål. Griffe, 224 mm POOL, Stahl gebürstet. Handle, 224 mm POOL, brushed steel.</p>	H B D/T
T3148	 <p>Greb, 224 mm POOL, mat sort Griffe, 224 mm POOL, matt schwarz Handle, 224 mm POOL, matt black</p>	H B D/T
T3150	 <p>Greb, 320 mm POOL, Krom Griffe, 320 mm POOL, Chrom Handle, 320 mm POOL, Chrome</p>	H B D/T
T3151	 <p>Greb, 320 mm POOL, børstet stål. Griffe, 320 mm POOL, Stahl gebürstet. Handle, 320 mm POOL, brushed steel.</p>	H B D/T

Varenr. Warenr. Article nr.	Beskrivelse / Beschreibung / Description	Mål i cm Mass Measure
T3152	 <p>Greb, 320 mm POOL, mat sort Griffe, 320 mm POOL, matt schwarz Handle, 320 mm POOL, matt black</p>	H B D/T
T3162	 <p>Skuffeindsats i glasklar PVC Schubladen Einsätz - glasklaren PVC Drawerinsert - glass clear PVC</p>	H 1,5 B 10,6 D/T 18,2
T3163	 <p>Skuffeindsats i glasklar PVC Schubladen Einsätz - glasklaren PVC Drawerinsert - glass clear PVC</p>	H 1,5 B 10,6 D/T 18,2
T3164	 <p>Skuffeindsats i glasklar PVC Schubladen Einsätz - glasklaren PVC Drawerinsert - glass clear PVC</p>	H 1,5 B 10,6 D/T 18,2
T3165	 <p>Skuffeindsats i glasklar PVC Schubladen Einsätz - glasklaren PVC Drawerinsert - glass clear PVC</p>	H 1,5 B 10,6 D/T 18,2
T3166	 <p>Plastbakke - hvid Plastiktray - weiss Plastic tray- white</p>	H 1,9 B 45,2 D/T 30,7
T3167-1	 <p>Opalglasplade excl. udtræk. Opalglassplatte ohne Auszug Opaque glass board without extension.</p>	H B D/T
T3169	 <p>Udtræksplade på skinner. Ausziehbare Platte auf Schienen. Pull-out plate.</p>	H B D/T
T3170	 <p>Vola HV1L blandingsbatteri, krom. Vola HV1L Mischbatterie, Chrom. Vola HV1L mixer tap, chrome.</p>	H B D/T
T3170-2	 <p>Vola HV1 elektronik blandingsbatteri, krom. For batteridrift. Vola HV1 Electronic Mischbatterie, Chrom. Für Batterie. Vola HV1 electronic mixer tap, chrome. For battery.</p>	H B D/T

Varenr. Warennr. Article nr.	Beskrivelse / Beschreibung / Description	Mål i cm Mass Measure
T3170-4	<p>Transformer for Varenr. T3170-2.</p> <p>Transformer für T3170 - 2.</p> <p>Substation for Article no. T3170-2.</p>	H B D/T
T3171	 <p>Miscea elektronisk blandingsbatteri, børstet stål.</p> <p>Miscea Mischbatterie, Gebürstet.</p> <p>Miscea mixer tap, brushed.</p>	H B D/T
T3171-4	 <p>Miscea elektronisk blandingsbatteri, børstet stål. Til vægmontage.</p> <p>Miscea Mischbatterie, Gebürstet. Für Wandmontage.</p> <p>Miscea mixer tap, brushed. For wallmounting.</p>	H B D/T
T3171-5	<p>Monteringskit til Miscea elektronikboks og sæbe/hånddesinfektion.</p> <p>Montagekit für Miscea Elektronik-Box und Seife/Hände Desinfektion.</p> <p>Mount for Miscea electronics box, and soap/disinfectant.</p>	H B D/T
T3171-6	 <p>Fjernbetjening til Miscea elektronisk blandingsbatteri.</p> <p>Fernbedienung für elektronische Miscea Mischbatterie.</p> <p>Remote control for Miscea mixer tap.</p>	H B D/T
T3172	 <p>Bundventil til porcelænsvask, krom.</p> <p>Bodenventil für Porzellanwaschbecken, Chrom.</p> <p>Drainplug for chinasink, chrome.</p>	H B D/T
T3173	 <p>Oras Electra Safety håndvaskarmatur. Batteridrift 3V, eller med transformer.</p> <p>Oras Electra Safety Armatur. Batteriebetrieben mit 3V oder mit Transformator.</p> <p>Oras Electra Safety hand tap. Battery operated 3V, or with transformer.</p>	H B D/T
T3173-1	 <p>Oras 6250FZ Electra berøringsfri blander med blandeventil. For batteridrift. Bluetooth forbindelse til justering.</p> <p>Oras 6250FZ Electra berührungsfreier Mischer mit Mischventil. Für Batterie. Bluetooth-Verbindung zur Anpassung.</p> <p>Oras 6250FZ Electra touch free mixer with mixvalve. For battery. Bluetooth connection for adjustment.</p>	H B D/T
T3173-4	 <p>Oras Optima 2722F armatur m/manuelle greb og berøringsfri funktion. Fast strømforsyning med stikprotransformer 230/ 5 V.</p> <p>Oras Optima 2722F Mischer mit manueller und berührungsloser fuktion. Netzteil für 230/ 5V.</p> <p>Oras Optima 2722F mixer with manual and tochfree function, power supply for 230/ 5V.</p>	H B D/T
T3174	 <p>Håndklædeholder.</p> <p>Handtuchhalter in Plexiglas</p> <p>Holder for towels.</p>	H 30 B 28 D/T 17

Varenr. Warennr. Article nr.	Beskrivelse / Beschreibung / Description	Mål i cm Mass Measure
T3174-2	 <p>Håndklædeholder, alu. Højre Handtuchhalter, Alu. Rechts Holder for towels, alu. Right</p>	<p>H 25 B 30 D/T 17</p>
T3175	 <p>Handskedispenser, 2 huller. Handschuhspender, 2 Löcher Dispenser for gloves, 2 openings.</p>	<p>H 48 B 30 D/T 17</p>
T3175-1	 <p>Handskedispenser, 2 huller Handschuhspender, 2 Löcher Dispenser for gloves, 2 openings.</p>	<p>H 48 B 30 D/T 22</p>
T3176	 <p>Handskedispenser, 2 huller for handsker, 1 hul for mundbind. Handschuhspender, 2 Löcher für Handschuhe, 1 Loch für Mundschutz. Dispenser for gloves, 2 openings for gloves, 1 opening for face masks.</p>	<p>H 48 B 30 D/T 17</p>
T3176-1	 <p>Handskedispenser, 2 huller for handsker, 1 hul for mundbind. Handschuhspender, 2 Löcher für Handschuhe, 1 Loch für Mundschutz. Dispenser for gloves, 2 openings for gloves, 1 opening for face masks.</p>	<p>H 48 B 30 D/T 22</p>
T3177	 <p>Handskedispenser, 3 huller for handsker, 1 hul for mundbind. Handschuhspender, 3 Löcher für Handschuhe, 1 Loch für Mundschutz. Dispenser for gloves, 3 openings for gloves, 1 opening for face masks.</p>	<p>H 67,2 B 30 D/T 17</p>
T3177-1	 <p>Handskedispenser, 3 huller for handsker, 1 hul for mundbind. Handschuhspender, 3 Löcher für Handschuhe, 1 Loch für Mundschutz. Dispenser for gloves, 3 openings for gloves, 1 opening for face masks.</p>	<p>H 67,2 B 30 D/T 22</p>
T3200	 <p>Polish, 1 L. Polish, 1 L. Polish, 1 L.</p>	<p>H B D/T</p>
T3201	 <p>Polish, 150 ml. Polish, 150 ml. Polish, 150 ml.</p>	<p>H B D/T</p>
T3202	 <p>Polish, 50 ml. Polish, 50 ml. Polish, 50 ml.</p>	<p>H B D/T</p>

Varenr. Warennr. Article nr.	Beskrivelse / Beschreibung / Description	Mål i cm Mass Measure
T3203	 <p>Hånddesinfektion, 10 stk. Hände Desinfektion, 10 stck. Disinfectant, 10 pcs.</p>	H B D/T
T3204	 <p>Hånd sæbe, 10 stk. Hände seife, 10 stck. Hand soap, 10 pcs.</p>	H B D/T
T3205	 <p>Hånddesinfektion til Miscea, Ethades 1 ltr. Kasse á 6 stk. Hände Desinfektion für Miscea, Ethades 1 ltr. Karton mit 6 Stück Disinfectant for Miscea, Ethades 1 ltr. Box with 6 pcs.</p>	H B D/T
T3205-1	 <p>Miscea hånddesinfektion Ethades, 1 ltr. flasker. Kasse med 6 stk. Miscea Händedesinfektion Ethades, 1 Liter Flaschen. Karton mit 6 Stück Miscea Hand Disinfection Ethades, 1 liter bottles. Box with 6 pcs.</p>	H B D/T
T3206	 <p>Miscea washlotion Eco Soap 1 ltr. Kasse med 6 stk. Miscea waschlotion Eco Soap 1 ltr. Karton mit 6 Stück Miscea washlotion Eco Soap 1 ltr. Box with 6 pcs.</p>	H B D/T
T3206-1	 <p>Miscea Washlotion Eco Soap 1 ltr. Flasker. Kasse med 6 stk. Miscea waschlotion Eco Soap 1 ltr. Flasche. Karton mit 6 Stück Miscea washlotion Eco Soap 1 ltr. Box with 6 pcs.</p>	H B D/T
T3207	 <p>Hånddesinfektion til CombiPlum elektronisk dispenser, 6 ps. á 1 L Händedesinfektion für CombiPlum elektronischer Spender, 6 stck á 1 L Hand disinfection for CombiPlum electronic dispenser, 6 pcs. of 1 Liter</p>	H B D/T
T3208	 <p>Hånd sæbe til CombiPlum elektronisk dispenser, 6 ps. á 1 L Handseife für CombiPlum elektronischer Spender, 6 stck á 1 L Hand soap for CombiPlum electronic dispenser, 6 pcs. of 1 Liter</p>	H B D/T
T3210	 <p>Laminatrens, 250 ml. Laminatreiniger, 250 ml. Laminate cleaner, 250 ml.</p>	H B D/T
T3401	 <p>Venstre sidebeklædning, tykkelse 2 cm. Seitenverkleidung links für Unterschränke, 2 cm. Left end panel, 2 cm.</p>	H 54,4 B 2 D/T 47

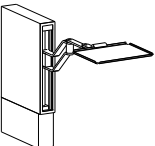
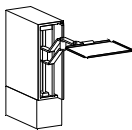
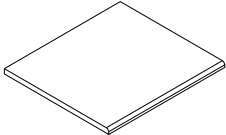
Varenr. Warennr. Article nr.	Beskrivelse / Beschreibung / Description	Mål i cm Mass Measure
T3402	 <p>Højre sidebeklædning, tykkelse 2 cm. Seitenverkleidung rechts für Unterschränke, 2 cm. Right end panel, 2 cm.</p>	H 54,4 B 2 D/T 47
T3405	 <p>Venstre sidebeklædning, tykkelse 2 cm. Seitenverkleidung links für Oberschränke, 2 cm. Left end panel, 2 cm.</p>	H 54,4 B 2 D/T 43/38
T3406	 <p>Højre sidebeklædning, tykkelse 2 cm. Seitenverkleidung rechts für Oberschränke, 2 cm. Right end panel, 2 cm.</p>	H 54,4 B 2 D/T 43/38
T3425	 <p>Højdejusterbart håndinstrumentbord monteret i 10 cm bredt skab. (51-88 cm). Med stor aluminiumsbakke. Höhenverstellbar Handinstrumententisch zum Schrank Einbau, 10 cm. (51-88 cm). Mit großer Aluminium Tray. Height adjustable hand instrument table mounted in 10 cm width cabinet. (51-88 cm). With large aluminium tray.</p>	H 54,4 B 10 D/T 45
T3425-1	 <p>Højdejusterbart håndinstrumentbord monteret i 20 cm bredt skab. (51-88 cm). 1 dør højre- eller venstrehængt. Med stor aluminiumsbakke. Höhenverstellbar Handinstrumententisch zum Schrank Einbau, 20 cm. (51-88 cm). 1 Tür rechts oder links Angeschlagen. Mit großer Aluminium Tray. Height adjustable hand instrument table mounted in 20 cm width cabinet. (51-88 cm). 1 door right or left. With large aluminium tray.</p>	H 54,4 B 20 D/T 47
T3430	 <p>Baldakin, pr. 10 cm. Baldachin, pro. 10 cm. Canapy, per. 10 cm.</p>	H B D/T 48
T3431	<p>Jalousi i alu-laminat pr. skab. Rolladen im Alu - Laminat, pro Schrank. Roll-front in alu laminate per cabinet.</p>	H B D/T
T3432	<p>Jalousi i andre farver. Rolladen im anderen Farben. Roll-front in other colors.</p>	H B D/T
T3433	<p>Tillæg for laminater i højglansfarver, pr. 10 cm Aufschlag für Laminat in Hochglanzfarben, pro 10 cm. Additional price for glossy laminates, per 10 cm.</p>	H B D/T
T3434	<p>Bly til afskærmning, pr. m2 Bleiabschirmung, pr. m2 Lead shielding, per m2</p>	H B D/T

Varenr. Warennr. Article nr.	Beskrivelse / Beschreibung / Description	Mål i cm Mass Measure
T3480	Ramme for fritstående skabe, EFTER TILBUD. Rahmen für freistehende Schränke, NUR AUF NACHFRAGE. Frame for freestanding cabinets, ACCORDING TO OFFER.	H B D/T
T002	6 cm skuffe. Schublade 6 cm. 6 cm Drawer.	H B D/T
T003	12 cm skuffe. Schublade 12 cm 12 cm Drawer.	H B D/T
T004	18 cm skuffe. Schublade 18 cm 18 cm drawer.	H B D/T
T005	24 cm skuffe. Schublade 24 cm 24 cm drawer.	H B D/T
I655001	Handskedispenser i aluminium. Handschuhspender auf Aluminium. Aluminum glove dispenser	H 30,9 B 15,8 D/T 14,2
I655002	Servietdispenser i aluminium. Serviettenspender auf Aluminium. Aluminum dispenser for paper towels	H 30,9 B 27,3 D/T 14,2
I655003	Sæbe/sprit dispenser i aluminium. Seife/Desinf. Spender, auf Aluminium. Aluminum dispenser for soap/desinf.	H 30,9 B 12,3 D/T 14,2
I655004	Krus dispenser i aluminium. Spender für Becher, auf Aluminium. Aluminum dispenser for cups.	H 30,9 B 9,3 D/T 14,2
I655005	Sæbe/sprit dispenser i aluminium. Elektronisk berøingsfri. Seife/Desinf. Spender, auf Aluminium. Elektronisch berührungsfrei. Aluminum dispenser for soap/desinf. Electronic touchfree.	H 30,9 B 12,9 D/T 14,2

Varenr. Warennr. Article nr.	Beskrivelse / Beschreibung / Description	Mål i cm Mass Measure
I655010	 <p>Gulvstander for dispenser. Dispenser sælges separat.</p> <p>Ständer für Spender. Der Spender ist separat verkauft.</p> <p>Stand for dispenser. The dispenser is sold separately.</p>	<p>H 135</p> <p>B</p> <p>D/T</p>



Danish Healthcare
Design A/S
Drejøvej 8
9500 Hobro

+45 9851 1633
info@dhdas.dk
www.dhdas.dk
CVR nr. 64194615

climo